



# 6





Cable Kit

ALPHA

 Sistema de información y comunicación con cable de acero. Ideal para su uso en escaparates, tiendas, etc.

 Système d'informations et communication avec câble d'acier. Idéal pour vitrines, magasins, etc.

 Modern and practical cable and tension system which allows you to quickly and easily set up exhibitions, displays, etc. The system is made of tensioners and cables ceiling/ floor and different models of grips in sizes and formats and methacrylate poster holders for all types of documents.

 Sistema de informação e comunicação com cabo de aço. Ideal para montras, lojas, etc.

 È un sistema espositivo basato su cavetti metallici ai quali, tramite appositi morsetti si fissano all'altezza desiderata le tasche portamessaggi o portadepliant.

 Stahlseil-Präsentationssystem. Ideal für jedes Schaufenster.

 System CableKit Alpha jest idealnym nośnikiem informacji na witrynie lub przy ścianie. System składa się ze stalowych kabli, szerokiej gamy uchwytów, napinaczy oraz szyn aluminiowych.





**KIT COMPLETO / KIT COMPLET / CABLE SYSTEM / KIT COMPLETO / KIT COMPLETI / KABELSYSTEM-SET / SYSTEM KABLOWY**





 Kit completo 3m. cable + 2 tensores (cromo-brillo) directos o para carril.

 For suspending from ceiling to floor. Consists of 3m steel cable, 1 ceiling fixing and 1 floor fixing.

 I kit sono completi di: 1 attacco superiore e 1 inferiore, 1 cavetto in acciaio 3m.

 Komplet składa się z linki stalowej o dł. 3m oraz 2 uchwytów mocowanych bezpośrednio do szyn.

 Kit complet de 3 m. Câble + 2 tenseurs (chromé-brillant) direct ou pour rails.

 Kit completo 3m. de cabo + 2 tensores (cromo-brilho) directos ou para carril.

 Seilsystem 3m. Drahtseil mit 2 verchromten Plattenhaltern.

12.118

Directo / Directs / Ceiling fixing / Directo / Direto / Deckenbefestigung / Uchwyt sufitowy

12.119

Para Carril / Pour Rail / Floor fixing / Para Carril / Per canalina / Für Schienenbefestigung / Uchwyt szynowy

**CONTRAPESO / CONTREPOIDS / ALUMINIUM LOAD / CONTRAPESO / CONTRAPPESO / GEGENGEWICHT / PRZECIWWAGA**



 Contrapeso de aluminio.

 Aluminium load.

 Contrappeso di alluminio.

 Aluminiowa przeciwwaga.

 Contrepoids en aluminium.

 Contrapeso em alumínio.

 Aluminium Gegengewicht.

12.117 170mm / Ø 40mm

**NEW**

PINZA / PINCE / CLIPS / PINÇA / PINZA / PLATTENHALTER / ZACISK

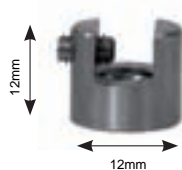

- Pinza fija directa para pared.
- Pince de fixation directe au mur.
- Wall fixing clip.
- Pinça fixa directa para parede.
- Pinza o morsetto fisso per parete.
- Einseitiger Plattenhalter zur Aufhängung.
- Zacisk mocowany bezpośrednio do ściany.

12.124 Pack 10 Uni.

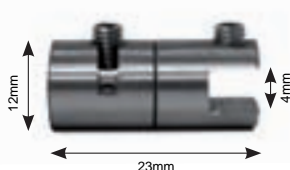

- Pinza fija sencilla para laterales.
- Pince fixe simple pour cotés.
- Panel clip for cable system.
- Pinça fixa para laterais.
- Pinza o morsetto per laterale.
- Verchromter Plattenhalter mit Gelenk.
- Zacisk boczny.

12.122 Pack 10 Uni.



- Pinza fija doble para interiores.
- Pince de fixation double pour l'intérieur.
- For holding two vertical adjacent panels in the cable system.
- Pinça fixa dupla para interiores.
- Pinza o morsetto doppio, per il fissaggio su cavi di due pannelli affiancati.
- Verchromter Plattenhalter mit Gelenk.
- Zacisk podwójny, wewnętrzny.

12.123 Pack 10 Uni.

CABLE DE ACERO TRENZADO / CÂBLE D'ACIER TRESSÉ / WIRE CABLE / CABO DE AÇO ENTRANÇADO / CAVETTI DI ACCIAIO / STAHLSEIL GEFLOCHTEN / LINKA STALOWA



- Cable de acero trenzado, 1mm de diámetro, en bobinas de 25 metros.
- Câble d'acier tressé, 1mm de diamètre, en bobine de 25 mètres.
- Material steel cable. Diameter: 1mm. Length of roll: 25m.
- Cavetti di acciaio. Diametro 1mm. Bobine di 25m.
- 25m Stahlseil-Rolle, Durchmesser 1mm.
- Linka stalowa, pleciona o średnicy 1mm. Długość zwoju: 25m.

12.121 25m / Ø 1mm

TENSOR / TENSEUR / CEILING FIXING / TENSOR / TENDIFILO / DECKEN/BODENHALTER / NAPINACZ

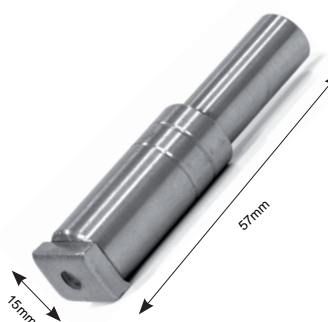

- Tensor cromo-brillo superior ó inferior.
- Tenseur, chromé brillant supérieur ou inférieur.
- For aluminium track. Material: Stainless steel. Colour: chrome.
- Tendifilo cromato da soffitto o da pavimento.
- Tensor cromo-brilho superior ou inferior.
- Verchromter Decken- oder Bodenhalter.
- Napinacz mocowany bezpośrednio do szyny.

12.120 Pack 10 Uni.

CARRIL ALUMINIO / RAIL D'ALUMINIUM / ALUMINIUM TRACK FOR CABLE SYSTEM / CARRIL ALUMÍNIO / CANALINA GUIDA IN ALLUMINIO / ALUMINIUMSCHIENE / SZYNA ALUMINIOWA

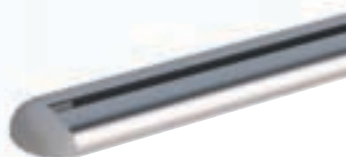

- Carril de aluminio superior (de techo) o inferior móvil.
- Rail mobile d'aluminium supérieur (de plafond) ou inférieur.
- Aluminium track for cable system. Length: 2m or 3m.
- Canalina guida in alluminio.
- Carril de alumínio móvel, superior (de tecto) ou inferior.
- Aluminiumschiene, als Deckenbefestigung oder frei hängend.
- Szyna aluminiowa mocowana do podłoża lub sufitu.

12.127 2000mm

12.128 3000mm

**NEW**

## BETA

 Sistema de exposición, información y comunicación con cable de acero. El sistema está fabricado en acero cromado. Se utiliza con cable de 3mm de diámetro.

 Système d'exposition, information, et communication avec câble d'acier. Le système est fabriqué en acier chromé. S'utilise avec un câble de 3mm de diamètre.

 Cable and tension system with flat shelves. Modern and practical cable and tension system which allows you to quickly and easily set up exhibitions, display, franchises, etc. The system is made of tensioners and cables and different simple and double grips.

 Sistema de exposição, informação e comunicação com cabo de aço. O sistema está fabricado em aço cromado. Utiliza-se com um cabo de 3mm de diâmetro.

 È un sistema espositivo basato su cavetti metallici ai quali, tramite appositi morsetti si fissano all'altezza desiderata le tasche portamessaggi o portadepliant. Cavetti diametro 3mm.

 Stahlseil-Regalsystem aus verchromtem Stahl. Stahlseil 3mm Durchmesser. Ideal für die Präsentation Ihrer Produkte.

 Ekspozycyjny system Beta. System składa się z stalowych linek o średnicy 3mm, licznej gamy uchwytów, tabliczek oraz prętów separujących.



**SOPORTE POLEA PARED / SUPPORT POULIE POUR MUR / CABLE SHELF CLIP / SUPORTE ROLDANA PARA PAREDE / SUPPORTI DI PULEGGIA A PARETE / UMLENKROLLE / UCHWYT ŚCIENNY**

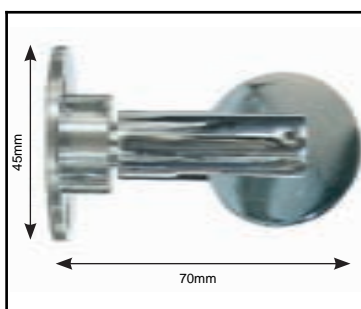



 Soporte polea de pared. Para un grosor de cable de 3mm.

 Cable shelf clip. For 3mm wire cable.

 Supporti di puleggia a parete a cavetto di 3mm di diametro.

 Uchwyt ścienny do kabla o średnicy 3mm.

 Support poulie pour mur. Pour un câble de 3mm d'épaisseur.

 Suporte roldana para parede. Para um cabo com 3mm de espessura.

 Umlenkrolle mit Wandabstandshalter für Stahlseile mit 3mm Durchmesser.

12.306 Pack 4 Uni.

**CABLE DE ACERO / CÂBLE D'ACIER / WIRE CABLE / CABO DE AÇO / CAVO IN ACCIAIO / STAHLSEIL / LINKA STALOWA**





 Cable de acero trenzado, 3mm de diámetro. Bobinas de 25m.

 Material steel cable. Diameter: 3mm. Length of roll: 25m.

 Cavo in acciaio diametro 3mm. Lunghezza: 25m.

 Linka stalowa, pleciona o średnicy 3mm i dł. 25m.

 Câble d'acier tressé, 3mm de diamètre. Rouleau de 25m.

 Cabo de aço entrançado com 3mm de diâmetro. Bobinas 25m.

 Stahlseil geflochten, 3mm Durchmesser. Rolle 25m.

12.311 25m / Ø 3mm.

**PINZA SENCILLA HORIZONTAL / PINCE SIMPLE HORIZONTALE / HORIZONTAL PANEL CLIP /  
PINÇA SIMPLE HORIZONTAL / MORSETTO MONOLATERALE / REGALHALTER / UCHWYT ŚCIENNY POZIOMY**

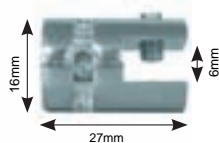



 Pinza sencilla horizontal. Ideal para cristal o acrílico de hasta 6mm de espesor.

 For cable system. Holds shelves up to 6mm thick. Colour: chrome.

 Morsetto monolaterale in ottone con finitura cromo lucido, per l'inserimento di tasche porta messaggio di spessore di 6mm massimo, da sospendere tramite cavo in acciaio.

 Uchwyt ścienny, poziomy. Idealny dopowierzchni szklanych lub akrylowych o grubości do 6mm.

 Pince simple horizontale. Idéal pour le verre ou l'acrylique jusqu'à 6mm d'épaisseur.

 Pinça simples horizontal. Ideal para vidro ou acrílico com uma espessura máxima de 6mm.

 Einseitiger Regalhalter für Glas-oder Acrylböden mit einer Stärke bis zu 6mm.

12.309 Pack 10 Uni.

**PINZA DOBLE HORIZONTAL / PINCE DOUBLE HORIZONTALE / DOUBLE PANEL CLIP / PINÇA DUPLA PARA VIDRIO /  
MORSETTO BILATERALE / DOPPELSEITIGER REGALHALTER / PODWÓJNY UCHWYT ŚCIENNY POZIOMY**

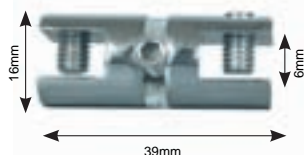



 Pinza doble horizontal. Ideal para cristal de hasta 6mm de espesor.

 For holding two vertical adjacent panels in the cable system. For panels up to 6mm thick. Colour: chrome.

 Morsetto bilaterale in ottone con finitura cromo lucido, per l'inserimento di tasche porta messaggio di spessore di 6 mm massimo, da sospendere tramite cavo in acciaio.

 Podwójny uchwyt ścienny, poziomy. Idealny do powierzchni szklanych lub akrylowych o grubości do 6mm.

 Pince double horizontale. Idéal pour le verre jusqu'à 6mm d'épaisseur.

 Pinça dupla horizontal. Ideal para vidro ou acrílico com uma espessura máxima de 6mm.

 Doppelseitiger Regalhalter für Glasböden mit einer Stärke bis zu 6mm.

12.310 Pack 10 Uni.

**SOPORTE DOBLE DE PARED / SUPPORT DOUBLE POUR MUR / WALL-MOUNTING CLIP DOUBLE / SUPORTE DUPLO  
PARA PAREDE / SUPPORTO DOPPIO DI PARETE / WINKELSEILSPANNER / PODWÓJNY UCHWYT ŚCIENNY**

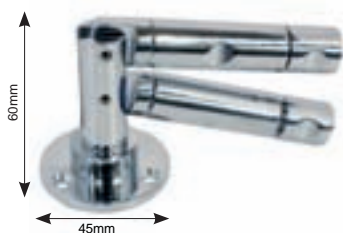



 Soporte doble de pared para la sujeción de dos cables de grosor 3mm.

 With joint for double cable system.

 Supporto doppio di parete per fissaggio di due cavi.

 Podwójny uchwyt ścienny na dwa kable o średnicy 3mm.

 Support double pour mur pour la fixation de 2 câbles de 3mm d'épaisseur.

 Suporte duplo para parede que permite fixar dois cabos com uma espessura de 3mm.

 Zweiarmliger Winkelseilspanner mit Wandabstandshalter für Stahlseile mit 3mm Durchmesser.

12.307 Pack 4 Uni.

**SEPARADOR DE PARED / SÉPARATEUR DE MUR / ROD SUPPORT / SEPARADOR DE PAREDE /  
DISTANZIALI DI PARETE / ABSTANDSHALTER / PRĘT SEPARUJĄCY**





 Barra separadora de cable. Realizada en acero cromado. Longitud: 273mm.

 For 2 point fixing of shelves. Material: Silver plated brass.

 Distanziali di parete. Lunghezza: 273mm.

 Pręt separujący kable. Wykonany ze stali chromowanej. Długość prętu: 273mm.

 Barre séparatrice de câble. Fabriquée en acier chromé. Longueur: 273mm

 Barra separadora de cabos. Fabricada em aço cromado. Comprimento: 273mm.

 Abstandshalter für Drahtseile, aus verchromtem Stahl. Länge 273mm.

12.308 Pack 4 Uni.

## DELTA

 Sistema de comunicación e información con cable de acero. Ideal para el uso en escaparates, paredes, agencias de viaje, inmobiliarias, etc. Terminación en acero cromado.

 Système de communication et information avec câble d'acier. Idéal pour une utilisation en vitrine, mur, agence de voyage, immobilier, etc. Finition en acier chromé.

 Cable and tension system. Modern and practical cable and tension which allows you to quickly and easily set up acrylic pockets. The system is made of tensioners and cables ceiling/floor or wall/wall, and extensive range of grips. Colour: Chrome.

 Sistema de comunicação e informação com cabo de aço. Ideal para utilizar em montras, paredes, agências de viagens, imobiliárias, etc. Acabamentos em aço cromado.

 Sistema di comunicazione tramite cavi di acciaio. È un prodotto particolarmente indicato per agenzie viaggi e immobiliari, perfetto per esporre ed intercambiare con facilità le vostre offerte.

 Stahlseil-Präsentationssystem aus verchromtem Stahl. Ideal für alle Arten von Verkaufs- und Ausstellungsräumen wie z.B. Reise- und Immobilienbüros.

 System CableKit Delta jest idealnym nośnikiem informacji na witrynie lub przy ścianie w biurach podróży, nieruchomości, itp. System składa się ze stalowych kabli, szerokiej gamy uchwytów, napinaczy oraz szyn aluminiowych.



**SOPORTE PARED-TECHO / SUPPORT MUR PLAFOND / WALL-MOUNTING CLIP FOR CEILING-WALL /  
SUPPORTO DE PAREDE-TECTO / SUPPORTO PER CAVO A PARETE / WINKELSEILSPANNER / UCHWYT ŚCIANA – SUFIT**





 Soporte móvil para pared o techo. Apto para cable de 1,5mm de diámetro.

 Wall-mounting clip for ceiling/wall. With joint for cable system. Material: brass. For cable of 1,5mm.

 Supporto per cavi di spessore 1,5 mm. a parete o a soffitto.

 Mobilny uchwyt ściana – sufit przeznaczony na linke o średnicy 1,5mm.

 Support mobile pour mur ou plafond. Apte pour un câble de 1.5mm de diamètre.

 Suporte móvel para parede ou tecto. Adequado para cabo com 1,5mm de diâmetro.

 Winkel-Seilspanner für Wand- oder Deckenbefestigung. Geeignet für Stahlseil mit 1,5mm Durchmesser.

12.316 Pack 4 Uni.

**SOPORTE TECHO-SUELO / SUPPORT PLAFOND SOL / WALL-MOUNTING CLIP FOR CEILING-FLOOR /  
SUPPORTO TECTO-CHÃO / FISSAGGIO A PAVIMENTO-SOFFITO / DECKEN/BODENHALTER / UCHWYT SUFIT – PODŁOGA**

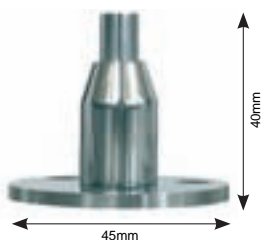



 Soporte fijo para techo o suelo. Apto para cable de 1,5mm ó 3mm.

 With joint for cable system. Material: brass. For cable of 1,5mm to 3mm.

 Fissaggio a pavimento o a soffitto per sistemi di cavi di spessore variabile da 1,5mm a 3mm.

 Uchwyt sufit – podłoga przeznaczony na linke o średnicy od 1,5mm do 3mm.

 Support fixe pour plafond ou sol. Apte pour un câble de 1,5 ou 3mm.

 Suporte fixo para tecto ou chão. Adequado para cabo de 1,5mm ou 3mm.

 Decken- oder Bodenhalter für Stahlseil mit 1,5 oder 3mm Durchmesser.

12.317 Pack 4 Uni.

**PINZA SENCILLA VERTICAL / PINCE SIMPLE VERTICAL / VERTICAL PANEL CLIP /  
PINÇA SIMPLE VERTICAL / CLIP PER PANNELLI / PLATTENHALTER / UCHWYT PIONOWY**

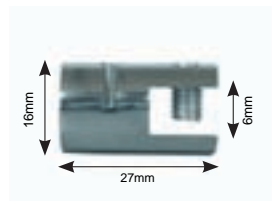



 Pinza sencilla vertical ideal para la colocación de carpetas acrílicas de hasta 6mm de espesor. Apto para cable de 1,5mm ó 3mm.

 Holds vertical panels up to 6mm thick. Colour: chrome. For cable of 1,5mm to 3mm.

 Clip per pannelli per sospendere un cavo in acciaio di spessore variabile da 1,5mm a 3 mm. Per metacrilato di 6mm di spessore.

 Pionowy uchwyt na kieszonki akrylowe o grubości do 6mm. Średnica linki: od 1,5mm do 3mm.

 Pince simple verticale, idéale pour la fixation de portes affiches en acrylique jusqu'à 6mm d'épaisseur. Apte pour câble de 1.5 ou 3mm.

 Pinça simple vertical para colocar pastas em acrílico com uma espessura máxima de 6mm. Adequado para cabo de 1,5mm ou 3mm.

 Einseitiger Plattenhalter, vertikale Nutzung. Geeignet für Stahlseil mit 1,5 oder 3mm Durchmesser. Acrylplattenstärke bis zu 6mm.

12.318 Pack 10 Uni.

**PINZA DOBLE VERTICAL / PINCE DOUBLE VERTICAL / DOUBLE PANEL CLIP / PINÇA DUPLA VERTICAL /  
DOPPIO CLIP / DOPPELSEITIGER PLATTENHALTER / UCHWYT PODWÓJNY PIONOWY**

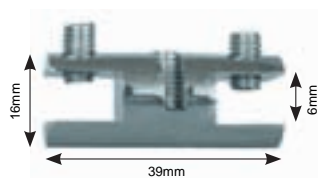



 Pinza doble vertical ideal para la colocación de carpetas acrílicas de hasta 6mm de espesor.

 For holding two vertical adjacent panels in the cable system. For panels up to 6mm thick. Colour: chrome.

 Doppio clip per il fissaggio di 2 pannelli adiacenti, di 6mm massimo, sul sistema di cavi.

 Pionowy uchwyt podwójny na kieszonki akrylowe o grubości do 6mm. Średnica linki: od 1,5mm do 3mm.

 Pince double verticale, idéale pour la fixation de portes affiches en acrylique allant jusqu'à 6mm d'épaisseur.

 Pinça dupla vertical ideal para colocar pastas em acrílico com uma espessura máxima de 6mm.

 Doppelseitiger Plattenhalter für Displaystärke bis zu 6mm.

12.319 Pack 10 Uni.

**CABLE DE ACERO / CÂBLE D'ACIER / WIRE CABLE / CABO DE AÇO / CAVO IN ACCIAIO / STAHLSEIL / LINKA STALOWA**



 Cable de acero trenzado, 1,5mm de diámetro. Bobinas de 25m.

 Material steel cable. Diameter: 1,5mm. Length of roll: 25m.

 Cavo in acciaio diametro 1,5mm. Lunghezza: 25m.

 Linka stalowa, pleciona o średnicy 1,5mm i dł. 25m.

 Câble d'acier tressé, 1,5mm de diamètre. Rouleau de 25m.

 Cabo de aço entrançado com 1,5mm de diâmetro. Bobinas 25m.

 Stahlseil geflochten, 1,5mm Durchmesser. Rolle 25m.

12.315 25m / Ø 1.5mm.

**CABLE DE ACERO / CÂBLE D'ACIER / WIRE CABLE / CABO DE AÇO / CAVO IN ACCIAIO /  
CAVO IN ACCIAIO / STAHLSEIL / LINKA STALOWA**





 Cable de acero trenzado, 3mm de diámetro. Bobinas de 25m.

 Material steel cable. Diameter: 3mm. Length of roll: 25m.

 Cavo in acciaio diametro 3mm. Lunghezza: 25m.

 Linka stalowa, pleciona o średnicy 3mm i dł. 25m.

 Câble d'acier tressé, 3mm de diamètre. Rouleau de 25m.

 Cabo de aço entrançado com 3mm de diâmetro. Bobinas 25m.

 Stahlseil geflochten, 3mm Durchmesser. Rolle 25m.

12.311 25m / Ø 3mm.

## GAMMA

 Sistema de comunicación e información con cable de acero. Ideal para el uso en escaparates, paredes, etc. Fabricado en aluminio "natural".

 Système de communication et d'information avec câble d'acier. Idéal pour l'usage en vitrines, murs, etc. Fabriqué en aluminium «naturel».

 Cable and tension system. Modern and practical cable and tension system kit which allows you to quickly and easily set up expositions, displays, shops, etc. The system is made of grips, tensioners and cables ceiling/floor or ceiling-suspended, an extensive range of grips. Aluminium natural silver.

 Sistema de comunicação com cabo de aço. Ideal para colocar em montras, paredes, etc. Fabricado em alumínio "natural".

 Sistema di comunicazione tramite cavi di acciaio. È un prodotto particolarmente indicato per agenzie viaggi e immobiliari, perfetto per esporre ed intercambiare con facilità le vostre offerte.

 Stahlseil-Präsentationssystem aus naturbelassenem Aluminium. Ideal für die Gestaltung von Schaufenstern und Wänden.

 System CableKit Gamma jest idealnym nośnikiem informacji. Idealny do zamontowania na ścianie. System składa się ze stalowych linek oraz uchwytów. Wykonany z aluminium.

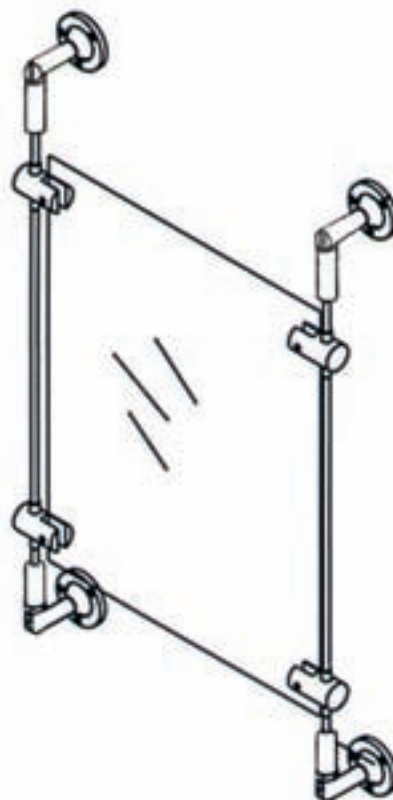



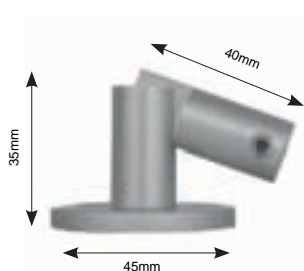

**SOPORTE MÓVIL SUPERIOR DE PARED-TECHO / SUPPORT MOBIL SUPÉRIEUR POUR MUR PLAFOND / WALL-MOUNTING TOP CLIP / SUPORTE MÓVEL SUPERIOR PARA PAREDE-TECTO / TENDIFILO DA PAVIMENTO / WINKELSEILSPANNER / RUCHOMY UCHWYT ŚCIANA - SUFIT**





 Soporte móvil superior de pared/techo para la sujeción de un cable de grosor 1,5mm ó 3mm.

 With joint for cable system. Colour: natural silver. For cable wire up to 1,5-3mm thick.

 Tendifilo mobile da pavimento o da soffitto con finitura alluminio, per sospendere un cavo in acciaio di spessore variabile da 1,5 a 3 mm.

 Ruchomy uchwyt ściana – sufit (górný), przeznaczony na linke o średnicy od 1,5mm do 3mm.

 Support mobil de mur/plafond pour la fixation d'un câble de 1.5 ou 3mm d'épaisseur.

 Suporte superior para parede tecto para fixação de um cabo com uma espessura de 1,5mm ou 3mm.

 Winkel-Seilspanner für Wand- oder Deckenbefestigung. Geeignet für Stahlseil mit 1,5 oder 3mm Durchmesser.

12.312 Pack 4 Uni.

**SOPORTE MÓVIL INFERIOR DE PARED-TECHO / SUPPORT MOBILE INFÉRIEUR POUR MUR PLAFOND / WALL-MOUNTING BOTTOM CLIP / SUPORTE MÓVEL INFERIOR PARA PAREDE-TECTO / TENDIFILO DA SOFFITO O PAVIMENTO / WINKELSEILSPANNER / RUCHOMY UCHWYT ŚCIANA - SUFIT**

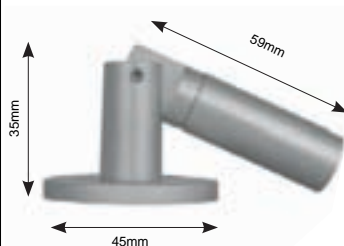



 Soporte móvil inferior de pared/techo para la sujeción de un cable de grosor 1,5mm ó 3mm.

 With joint for cable system. Colour: natural silver. For cable wire up to 1,5-3mm thick.

 Tendifilo mobile da pavimento o da soffitto con finitura alluminio, per sospendere un cavo in acciaio di spessore variabile da 1,5 a 3 mm.

 Ruchomy uchwyt ściana – sufit (dolny), przeznaczony na linke o średnicy od 1,5mm do 3mm.

 Support mobil inferieur de mur/plafond pour la fixation d'un câble de 1.5 ou 3mm d'épaisseur.

 Suporte inferior para parede / tecto para fixação de um cabo com uma espessura de 1,5mm ou 3mm.

 Winkel-Seilspanner für Wand- oder Deckenbefestigung. Geeignet für Stahlseil mit 1,5 oder 3mm Durchmesser.

12.313 Pack 4 Uni.

**PINZA SENCILLA "AL" / PINCE SIMPLE "AL" / VERTICAL PANEL CLIP / PINÇA SIMPLE "AL" / MORSETTO SINGOLO VERICALE / PLATTENHALTER / UCHWYT PROSTY**

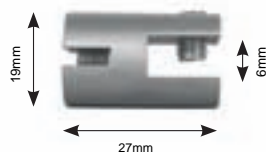



 Pinza sencilla vertical para sujeción de una portagráfica. Para un grosor de cable de 1,5mm ó 3mm. Permite la sujeción de material de hasta 6mm de espesor.

 For cable system. Holds up to 6mm thick panels. Colour: natural silver.

 Morsetto singolo verticale per fissaggio di tasca in metacrilato 6mm di spessore.

 Uchwyt prosty, pionowy do tabliczek informacyjnych o grubości do 6mm. Przeznaczony na linke o grubości od 1,5mm do 3mm.

 Pince simple verticale pour la fixation d'un porte affiche. Pour un câble de 1,5 ou 3mm d'épaisseur. Permet la fixation de matériaux allant jusqu'à 6mm d'épaisseur.

 Pinça simple vertical para a fixação de uma porta-impressão. Permite a utilização de um cabo de 1,5mm ou 3mm. Fixa material com uma espessura até 6mm.

 Einseitiger Plattenhalter, vertikale Nutzung. Geeignet für Stahlseil mit 1,5 oder 3mm Durchmesser. Plattenstärke bis zu 6mm.

12.314 Pack 10 Uni.

## EPSILON

 Sistema de comunicación por cable. Ideal para agencias de viaje, inmobiliarias, bancos, etc. Válido para cable de 1,5 ó 3mm de diámetro. Terminación en acero cromado.

 Système de communication par câble. Idéal pour les agences de voyages, immobilières, banques, etc. Convient pour des câbles de 1,5 ou 3mm de diamètre. Finition en acier chromé.

 Modern and practical cable and tension system which allows you to quickly and easily set up exhibitions, display, etc. The system is made of tensioners and cables ceiling/floor or wall/wall, an extensive range of grips. Finish in chrome.

 Sistema de comunicação por cabo. Ideal para agências de viagens, imobiliárias, bancos, etc. Adequado para cabo de 1,5mm ou 3mm de diâmetro. Acabamentos em aço cromado.

 Sistema di comunicazione tramite cavi di acciaio. È un prodotto particolarmente indicato per agenzie viaggi e immobiliari, perfetto per esporre ed intercambiare con facilità le vostre offerte. Cavi di spessore variabile da 1,5mm a 3mm.

 Stahlseil-Präsentationssystem aus verchromtem Stahl. Geeignet für Stahlseil mit 1,5 oder 3mm Durchmesser. Ideal für die Gestaltung von Wänden in Verkaufs- oder Ausstellungsräumen.

 System CableKit Epsilon - idealny nośnik informacji na witrynie lub przy ścianie w biurach podróży, biurach nieruchomości czy w bankach. System składa się ze stalowych kabli o średnicy od 1,5mm do 3mm oraz uchwytów.

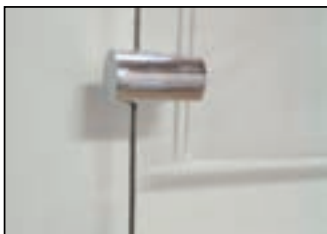

**SOPORTE MÓVIL SUPERIOR DE PARED-TECHO / SUPPORT MOBIL SUPÉRIEUR DE MUR-PLAFOND / WALL-MOUNTING CLIP / SUPORTE MÓVEL SUPERIOR DE PAREDE-TECTO / TENDIFILO DA SOFFITO O PAVIMENTO / WINKELSEILSPANNER / RUCHOMY UCHWYT ŚCIANA – SUFIT**

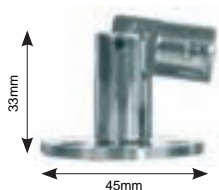

Soporte móvil superior para fijación de cable en paredes o techos.

With joint for cable system.  
Material: brass.

Tendifilo mobile superiore per fissaggio di cavetto a pareti o soffitto.

Ruchomy uchwyt ściana – sufit, przeznaczony na linke o średnicy od 1,5mm do 3mm. Wykonany ze stali nierdzewnej.

Support mobil supérieur pour la fixation de câbles dans un mur ou plafond.

Suporte móvel superior para a fixação de cabos a paredes ou tectos.

Winkel-Seilspanner für Wand- oder Deckenbefestigung.

12.320 Pack 4 Uni.

**SOPORTE MÓVIL INFERIOR DE PARED-TECHO / SUPPORT MOBILE INFÉRIEUR POUR MUR-PLAFOND / WALL-MOUNTING CLIP / SUPORTE MÓVEL INFERIOR DE PAREDE-TECTO / TENDIFILO DA SOFFITO O PAVIMENTO / WINKELSEILSPANNER / RUCHOMY UCHWYT ŚCIANA – SUFIT**

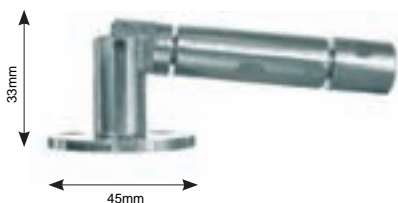

Soporte móvil inferior para fijación de cable en paredes o techos. Posibilidad de acoplar a perfilera de aluminio.

With joint for cable system.  
Material: brass.

Tendifilo mobile inferiore per fissaggio di cavetti a pareti o soffitto. Può essere abbinato a profili in alluminio.

Ruchomy uchwyt ściana – sufit, przeznaczony na linke o średnicy od 1,5mm do 3mm. Wykonany ze stali nierdzewnej. Możliwość mocowania z szyną.

Support mobil inférieur pour la fixation de câble dans un mur ou plafond. Possibilité de l'adapter à un profil d'aluminium.

Suporte móvel inferior para a fixação de cabos em paredes ou tectos. Possibilidade de adequar perfil de alumínio.

Winkel-Seilspanner mit Wandabstandshalter zur Befestigung an Wand, Decke oder am Aluminiumprofil.

12.321 Pack 4 Uni.

**PINZA SENCILLA VERTICAL / PINCE SIMPLE VERTICALE / VERTICAL PANEL CLIP / PINÇA SIMPLES VERTICAL / CLIP PER PANNELLI / PLATTENHALTER / UCHWYT PIONOWY**

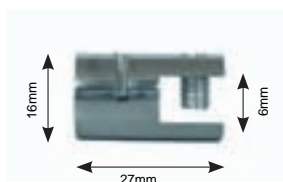

Pinza sencilla vertical ideal para la colocación de carpetas acrílicas de hasta 6mm de espesor. Apto para cable de 1,5mm ó 3mm.

Holds vertical panels up to 6mm thick. Colour: chrome. For cable of 1,5mm to 3mm.

Clip per pannelli per sospendere un cavo in acciaio di spessore variabile da 1,5 a 3mm. Per metacrilato di 6mm di spessore.

Uchwyt do zamocowań pionowych. Przeznaczony do linki o średnicy od 1,5mm do 3mm. Grubość kieszonki akrylowej: do 6mm.

Pince simple vertical, idéal pour la fixation de portes affiches en acrylique allant jusqu'à 6mm d'épaisseur. Apte pour des câbles de 1,5 ou 3 mm.

Pinça simples vertical para colocar pastas em acrílico com uma espessura máxima de 6mm. Adequado para cabo de 1,5mm ou 3mm.

Einseitiger Plattenhalter, vertikale Nutzung. Geeignet für Stahlseil mit 1,5 oder 3mm Durchmesser. Acrylplattenstärke bis zu 6mm.

12.318 Pack 10 Uni.

**PINZA DOBLE VERTICAL / PINCE DOUBLE VERTICALE / DOUBLE PANEL CLIP / PINÇA DUPLA VERTICAL / DOPPIO CLIP / DOPPELSEITIGER PLATTENHALTER / PODWÓJNY UCHWYT PIONOWY**

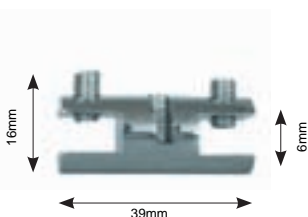

Pinza doble vertical ideal para la colocación de carpetas acrílicas de hasta 6mm de espesor.

For holding two vertical adjacent panels in the cable system. For panels up to 6mm thick. Colour: chrome.

Doppio clip per il fissaggio di 2 pannelli adiacenti sul sistema di cavi.

Podwójny uchwyt pionowy dokieszonek akrylowych o grubości do 6mm.

Pince double verticale, idéal pour la fixation de portes affiches en acrylique allant jusqu'à 6mm d'épaisseur.

Pinça dupla vertical ideal para colocar pastas em acrílico com uma espessura máxima de 6mm.

Doppelseitiger Plattenhalter, ideal für Acrylplattenstärke bis zu 6mm.

12.319 Pack 10 Uni.

## SIGMA

 Sistema de exposición, comunicación e información con varilla de acero. Ideal para su uso en locales comerciales, oficinas, tiendas, etc. Se utiliza con varilla de acero de 5mm de diámetro.

 Système d'exposition, communication et information avec baguette d'acier. Idéal pour un usage en locaux commerciaux, bureaux, magasins, etc. S'utilise avec baguette d'acier de 5mm de diamètre.

 Modern and practical Rod Display System which allows you to quickly and easily set up exhibitions, displays, etc. For 5mm diameters steel bar.

 Sistema de exposição, comunicação e informação com varinha de aço. Ideal para colocar em montras, lojas, etc. Utilização com varinha de aço de 5mm de diâmetro.

 Sigma un affascinante sistema di presentazione, nobile nell'aspetto e robusto nella struttura. Con astine invece di cavi ed un design elegante e ottimo per l'esposizione di pannelli, lavagne e segnaletica, sia a soffitto che a parete. Diametro 5mm.

 Schilderbefestigungs-System aus Edelstahl-Stangen. Ideal für Büro- und Geschäftsräume. Stangen, durchmesser: 5mm.

 System CableKit Sigma - idealny nośnik informacji we wszelkiego rodzaju lokalach komercyjnych, biurach lub w bankach. System składa się ze stalowych prętów o średnicy 5mm oraz uchwytów.

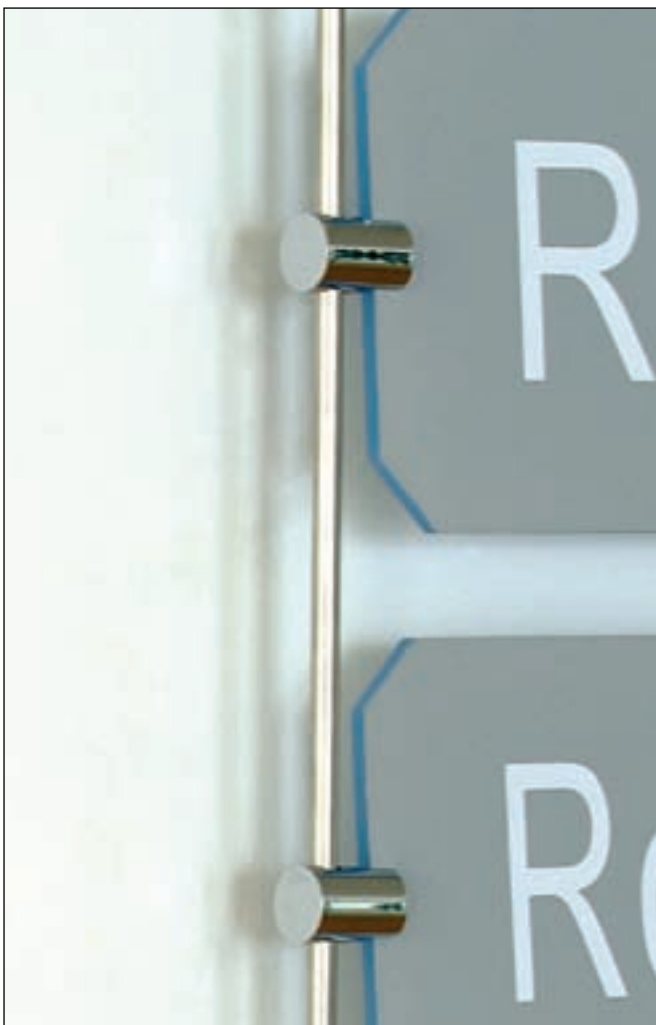



**VARILLA DE ACERO / BAGUETTE D'ACIER / STEEL BAR / VARINHA DE AÇO /  
ASTINA IN ACCIAIO / EDELSTAHLSTANGE / PRĘT STALOWY**



 Varilla realizada en acero de 5mm de grosor. Disponible en distintos tamaños.

 Material: Steel. Different lengths are available. Diameter: 5mm.

 Astina costruita in acciaio. Diametro: 5mm. Disponibile in diversi misure.

 Pręt stalowy o średnicy 5mm. Do dyspozycji w trzech rozmiarach.

 Baguette fabriquée en acier de 5mm d'épaisseur. Disponible en différentes tailles.

 Varinha fabricada em aço de 5mm de espessura. Disponível em vários tamanhos.

 Edelstahl-Stange, Durchmesser: 5mm. In verschiedenen Längen verfügbar.

12.343 5x1000mm

12.344 5x1500mm

12.345 5x2000mm

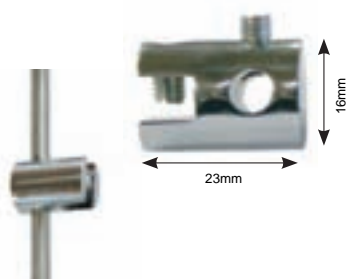
**PINZA SENCILLA VERTICAL PARA VARILLA / PINCE SIMPLE VERTICALE POUR BAGUETTE /  
GLASS SUPPORT BASE / PINÇA SIMPLES VERTICAL PARA VARINHA /  
MORSETTO SINGOLO VERTICALE / PLATTENHALTER / UCHWYT PIONOWY**



 Pinza sencilla vertical ideal para la colocación de carpetas acrílicas de hasta 5mm de espesor.

 For glass thickness 5mm. Material: Brass.

 Morsetto singolo verticale ideale per tasca in metacrilato di 5mm.

 Uchwyt pionowy przeznaczony do mocowań z prętem. Idealna do mocowań tabliczek akrylowych lub szklanych o grubości do 5mm.

 Pince simple verticale, idéal pour la fixation de portes affiches en acrylique allant jusqu'à 5mm d'épaisseur.

 Pinça simples vertical ideal para colocar pastas em acrílico de 5mm de espessura.

 Einseitiger Plattenhalter, vertikale Nutzung. Plattenstärke bis zu 5mm.

12.341 Pack 10 Uni

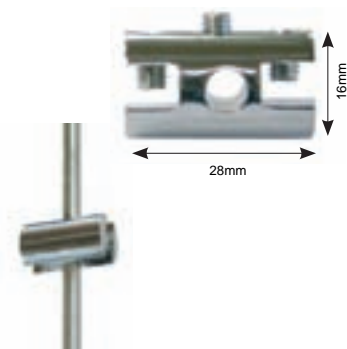
**PINZA DOBLE VERTICAL PARA VARILLA / PINCE DOUBLE VERTICALE POUR BAGUETTE /  
MIDDLE GLASS SUPPORT BASE / PINÇA DUPLA VERTICAL PARA VARINHA / MORSETTO DOPPIO VERTICALE /  
DOPPELSEITIGER PLATTENHALTER / PODWÓJNY UCHWYT PIONOWY**



 Pinza doble vertical ideal para la colocación de carpetas acrílicas de hasta 5mm de espesor.

 Middle glass support base. For glass thickness 5mm. Material: Brass.

 Morsetto doppio verticale ideale per tasca in metacrilato di 5mm.

 Podwójny uchwyt pionowy do mocowań z prętem. Idealny do mocowań tabliczek akrylowych lub szklanych o grubości do 5mm.

 Pince double verticale, idéal pour la fixation de portes affiches en acrylique allant jusqu'à 5mm d'épaisseur.

 Pinça dupla vertical ideal para colocar pastas em acrílico de 5mm de espessura.

 Doppelseitiger Plattenhalter, vertikale Nutzung. Plattenstärke bis zu 5mm.

12.342 Pack 10 Uni

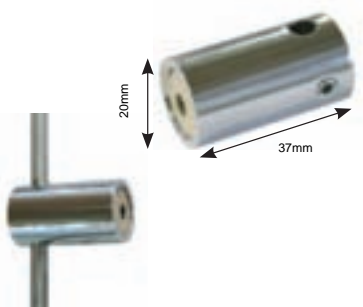
**SOPORTE DE PARED PARA VARILLA / SUPPORT DE MUR POUR BAGUETTE / WALL FIXING / SUPORTE DE  
PAREDE PARA VARINHA / FISSAGGIO A PARETE / WANDHALTER / UCHWYT ŚCIENNY**



 Soporte de pared para la sujeción de una varilla de grosor de 5mm.

 Wall fixing for 5mm rod. Material: brass.

 Fissaggio a parete per astine con diametro 5mm. Colore: cromato.

 Uchwyt mocujący pręt o średnicy 5mm ze ścianą.

 Support de mur pour la fixation d'une baguette de 5mm d'épaisseur.

 Suporte para parede que permite fixar uma varinha com uma espessura de 5mm.

 Wandhalter für Edelstahl-Stange mit Durchmesser von 5mm.

12.340 Pack 10 Uni

## FREE STANDING



Sistema de cables sobre soporte bastidor de aluminio con patas cromadas y niveladores. El sistema se compone de bastidores, tensores, pinzas y cable de 1,5mm de diámetro. Carpetas de metacrilato no incluidas.



Système de câble sur support coulissant d'aluminium, avec pieds chromés et réglables. Le système se compose de coulisses, tenseurs, pinces et câble de 1,5mm de diamètre. Portes affiches acrylique non inclus.



Cable system displayed in a mobile aluminium framework with levellers. The system is composed for aluminium framework, tensioners, single and double panel clips 1,5mm steel cable. Acrylic pocket not includes.



Sistema de cabos sob suporte bastidor de alumínio com patas cromadas e niveladoras. O sistema é composto por bastidores, tensores, pinças e cabo de 1,5mm de diâmetros. Pastas em acrílico não incluídas.



Sistema espositivo autoportante Free standing. Il sistema è composto da tensori e cavi posti in una elegante struttura in alluminio con montanti ellittici. Il sistema si completa con una vastissima gamma di accessori. Cartelle in acrilico non compresi.



Display-Ständer als Aluminiumrahmen mit verchromten Füßen und Seilsystem. Fußmodule justierbar. System besteht aus Rahmengestell, Seilspannern, Plattenhaltern und Stahlseil mit 1,5mm Durchmesser. Acrylplatten nicht inklusive.



System CableKit Standing – idealny nośnik informacji w biurach, bankach lub instytucjach użyteczności publicznej. Wykonany z ram aluminiowych, utrzymujących kieszonki na foldery, połączone ze sobą za pomocą linek stalowych, uchwytów oraz napinaczy. Średnica linki stalowej: 1,5mm.

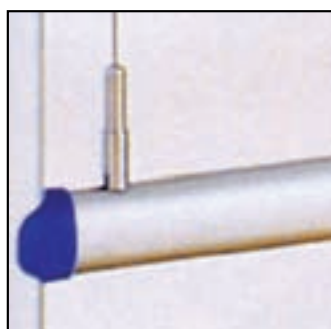
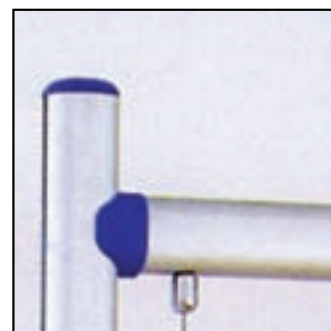

## FREE STANDING 900X2120MM



Contenido:

- Bastidor: 1
- Tensor superior: 4
- Tensor inferior: 4
- Pinza simple: 24
- Pinza doble: 24
- Cable 1,5mm: 8,8m



Includes:

- Framework: 1
- Top tensioner: 4
- Bottom tensioner: 4
- Single panel clip: 24
- Double panel clip: 24
- Cable 1,5mm: 8,8m



Contenuto:

- Struttura: 1
- Attacco superiore: 4
- Attacco inferiore: 4
- Morsetto singolo: 24
- Morsetto doppio: 24
- Cavetto 1,5mm: 8,8m



Zestaw:

- Ramy aluminiowe wyposażone w stopki niwelujące: 1
- Napinacz górny: 4
- Napinacz dolny: 4
- Uchwyt prosty: 24
- Uchwyt podwójny: 24
- Linka stalowa 1,5mm: dł 8,8m



Contenu:

- Coulisse: 1
- Tenseur supérieur: 4
- Tenseur inférieur: 4
- Pince simple: 24
- Pince double: 24
- Câble 1.5mm: 8.8m



Conteúdo:

- Bastidor: 1
- Tensor superior: 4
- Tensor inferior: 4
- Pinça simples: 24
- Pinça dupla: 24
- Cabo 1,5mm: 8,8m



Enthält:

- Rahmengestell: 1
- Seilspanner oben: 4
- Seilspanner unten: 4
- Einseitiger Plattenhalter: 24
- Doppelseitiger Plattenhalter: 24
- Stahlseil: 1,5mm: 8,8m

12.354 900x2120mm

## FREE STANDING 1200X2120MM

-  Contenido:
- Bastidor: 1
  - Tensor superior: 5
  - Tensor inferior: 5
  - Pinza simple: 24
  - Pinza doble: 36
  - Cable 1,5mm: 10,6m

-  Contenu:
- Coulisse: 1
  - Tenseur supérieur: 5
  - Tenseur inférieur: 5
  - Pince simple: 24
  - Pince double: 36
  - Câble 1.5mm: 10.6m

-  Includes:
- Framework: 1
  - Top tensioner: 5
  - Bottom tensioner: 5
  - Single panel clip: 24
  - Double panel clip: 36
  - Cable 1,5mm: 10,6m

-  Conteúdo:
- Bastidor: 1
  - Tensor superior: 5
  - Tensor inferior: 5
  - Pinça simples: 24
  - Pinça dupla: 36
  - Cabo 1,5mm: 10,6m

-  Contenuto:
- Struttura: 1
  - Attacco superiore: 5
  - Attacco inferiore: 5
  - Morsetto singolo: 24
  - Morsetto doppio: 36
  - Cavetto 1,5mm: 10,6m

-  Enthält:
- Rahmengestell: 1
  - Seilspanner oben: 5
  - Seilspanner unten: 5
  - Einseitiger Plattenhalter: 24
  - Doppelseitiger Plattenhalter: 36
  - Stahlseil: 1,5mm: 10,6m

-  Zestaw:
- Ramy aluminiowe wyposażone w stopki niwelujące: 1
  - Napinacz górny: 5
  - Napinacz dolny: 5
  - Uchwyt prosty: 24
  - Uchwyt podwójny: 36
  - Linka stalowa 1,5mm: dł 10,6m

12.355 1200x2120mm



## FREE STANDING 1500X2120MM

-  Contenido:
- Bastidor: 1
  - Tensor superior: 6
  - Tensor inferior: 6
  - Pinza simple: 24
  - Pinza doble: 48
  - Cable 1,5mm: 12,72m

-  Contenu:
- Coulisse: 1
  - Tenseur supérieur: 6
  - Tenseur inférieur: 6
  - Pince simple: 24
  - Pince double: 48
  - Câble 1.5mm: 12.72m

-  Includes:
- Framework: 1
  - Top tensioner: 6
  - Bottom tensioner: 6
  - Single panel clip: 24
  - Double panel clip: 48
  - Cable 1,5mm: 12,72m

-  Conteúdo:
- Bastidor: 1
  - Tensor superior: 6
  - Tensor inferior: 6
  - Pinça simples: 24
  - Pinça dupla: 48
  - Cabo 1,5mm: 12,72m

-  Contenuto:
- Struttura: 1
  - Attacco superiore: 6
  - Attacco inferiore: 6
  - Morsetto singolo: 24
  - Morsetto doppio: 48
  - Cavetto 1,5mm: 12,72m

-  Enthält:
- Rahmengestell: 1
  - Seilspanner oben: 6
  - Seilspanner unten: 6
  - Einseitiger Plattenhalter: 24
  - Doppelseitiger Plattenhalter: 48
  - Stahlseil: 1,5mm: 12,72m

-  Zestaw:
- Ramy aluminiowe wyposażone w stopki niwelujące: 1
  - Napinacz górny: 6
  - Napinacz dolny: 6
  - Uchwyt prosty: 24
  - Uchwyt podwójny: 48
  - Linka stalowa 1,5mm: dł 12,72m

12.356 1500x2120mm



**CARPETA METACRILATO / PORTE AFFICHES / ACRYLIC POCKET / PASTA EM ACRÍLICO / CARTELLA IN ACRILICO TRASPARENTE / ACRYLGLASTASCHE / KIESZONKA AKRYLOWA**

 Carpeta de metacrilato transparente horizontal o vertical en tamaño A4 y A3.

 Portes affiches en acrylique transparents horizontaux ou verticaux en format A3 ou A4.

 Acrylic Pocket for cable system. Sizes A4 or A3.

 Pasta em acrílico transparente horizontal ou vertical em tamanho A4 e A3.

 Cartella orizzontale e verticale, in acrilico trasparente. Disponibile A3 e A4.

 Transparente Acryltaschen in DIN A4 und A3, vertikal oder horizontal nutzbar.

 Przezroczysta kieszonka akrylowa. Format A4 i A3. Pozioma lub pionowa.

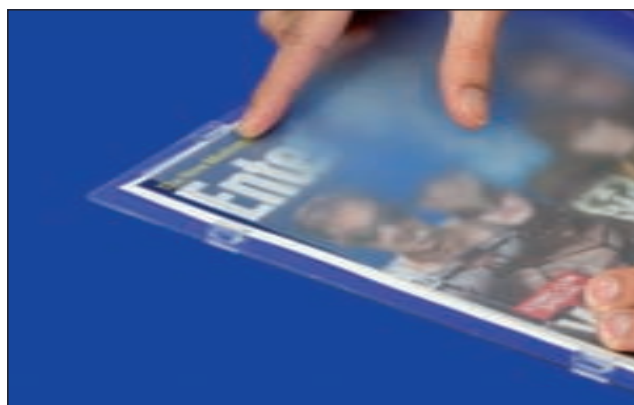
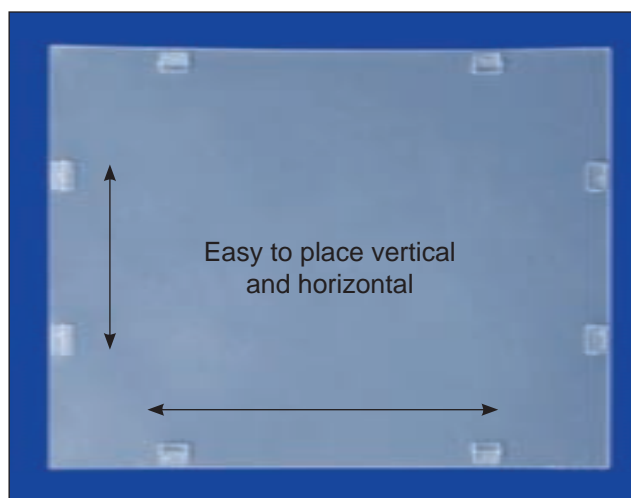

12.125 A4 Horizontal



12.351 A3 Horizontal



12.126 A4 Vertical



12.352 A3 Vertical



12.420 A4