



# 8





Acrílicos / Acryliques /  
Leaflet dispensers / Acrílicos /  
Espositore in metacrilato / Acryl /  
Akryl

**PORTAGRÁFICA ABIERTA “T” / PORTE VISUEL OUVERT EN “T” / MENU CARD HOLDER “T” OPEN / PORTA-IMPRESSÕES ABERTA “T” / ESPOSITORE CON BASE “T” / T - STÄNDER OFFEN / STOJACZEK “T”**

 Portagráfica en forma de “T” invertida. Fabricadas en metacrilato de 3mm en el tamaño A3, y en metacrilato de 2mm el resto. Tamaños: A3, A4, A5 y A6.

 Porte visuels en forme de T inversé. Fabriqué en acrylique de 3mm pour la dimension A3 et en acrylique de 2mm pour les autres dimensions. Disponible en: A3, A4, A5 et A6.

 Menu card holder “T” open. Material: 2mm acrylic for A4, A5 and A6. 3mm acrylic for A3.

 Porta-impressões em forma de “T” invertido. Fabricado em acrílico de 3mm no tamanho A3, e em acrílico de 2mm os restantes tamanhos. Tamanho: A3, A4, A5 e A6.

 Porta Informazioni da tavolo in metacrilato trasparente di 3mm in dimensione A3 è in metacrilato di 2mm in dimensione A4, A5 e A6.

 Menühalter in T - Form aus 2mm Acrylglas, in DIN A4, A5 und A6, und in DIN A3 aus 3mm Acrylglas.

 Stojaczek ekspozycyjny na plakat z grafiką. Posiada kształt “T”. Wykonany z plexi o grubości 3mm w formacie A3 i reszta z plexi o grubości 2mm: A3, A4, A5, A6.

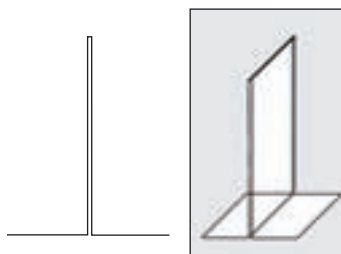
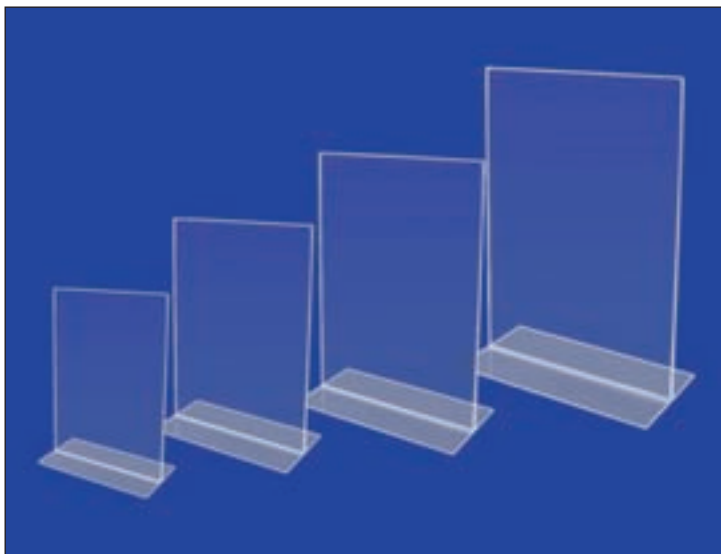



13.069	A3	Pack 10 Uni.
13.027	A4	Pack 10 Uni.
13.028	A5	Pack 10 Uni.
13.068	A6	Pack 10 Uni.

**PORTAGRÁFICA CERRADA “T” / PORTE VISUEL FERME EN “T” / MENU CARD HOLDER “T” CLOSED / PORTA-IMPRESSÕES FECHADA “T” / ESPOSITORE PIEGATO IN FORMA DI “T” / T - STÄNDER GESCHLOSSEN / STOJACZEK “T” ZAMKNIĘTY**





 Portagráfica en forma de “T” invertida. Fabricadas en metacrilato de 3mm en el tamaño A3, y en metacrilato de 2mm el resto. Tamaños: A3, A4, A5 y A6.

 Porte visuels en forme de T inversé. Fabriqué en acrylique de 3mm pour la dimension A3 et en acrylique de 2mm pour les autres dimensions. Disponible en: A3, A4, A5 et A6.

 Menu card holder “T” closed. Material: 2mm acrylic for A4, A5 and A6. 3mm acrylic for A3.

 Porta-impressões em forma de “T” invertido. Fabricado em acrílico de 3mm no tamanho A3, e em acrílico de 2mm os restantes tamanhos. Tamanho: A3, A4, A5 e A6.

 Porta Informazioni da tavolo in metacrilato trasparente di 3mm in dimensione A3 è in metacrilato di 2mm in dimensione A4, A5 e A6.

 Menühalter in T - Form aus 2mm Acrylglas, in DIN A4, A5 und A6, und in DIN A3 aus 3mm Acrylglas.

 Stojaczek ekspozycyjny na plakat z grafiką. Posiada kształt “T”. Wykonany z plexi o grubości 3mm w formacie A3 i reszta z plexi o grubości 2mm: A3, A4, A5, A6.

13.000	A3	Pack 10 Uni.
13.001	A4	Pack 10 Uni.
13.002	A5	Pack 10 Uni.
13.003	A6	Pack 10 Uni.

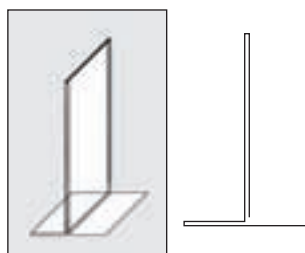



**PORTAGRÁFICA SOBREMESA / PORTE BROCHURES A POSER / ACRYLIC "L-DISPLAY" / PORTA-IMPRESSÕES SOB MESA / ESPOSITORE DA BANCO / L - STÄNDER / STOJACZEK "L"**

 Portagráfica de sobremesa. Fabricadas en metacrilato de 3mm en el tamaño A3, y en metacrilato de 2mm el resto. Tamaños: A3, A4, A5 y A6.

 Porte brochures a positionner sur une table. Fabriqué en acrylique de 3mm pour la dimension A3 et en acrylique de 2mm pour les autres dimensions. Disponible en: A3, A4, A5 et A6.

 Acrylic "L-Display". Material: 2mm acrylic for A4, A5 and A6. 3mm acrylic for A3.

 Porta-impressões para colocar sob mesas. Fabricado em acrílico de 3mm no tamanho A3, e em acrílico de 2mm os restantes tamanhos. Tamanho: A3, A4, A5 e A6.

 Espositore da banco piegati, in metacrilato trasparenti di 3mm in dimensione A3 è in metacrilato di 2mm in dimensione A4, A5 e A6.

 Tischständer in L - Form aus 2mm Acrylglas, in DIN A4, A5 und A6, und in DIN A3 aus 3mm Acrylglas.

 Stojaczek ekspozycyjny na plakat z grafiką. Posiada kształt "L". Wykonany z plexi o grubości 3mm. Dostępny w formatach: A3, A4, A5, A6.

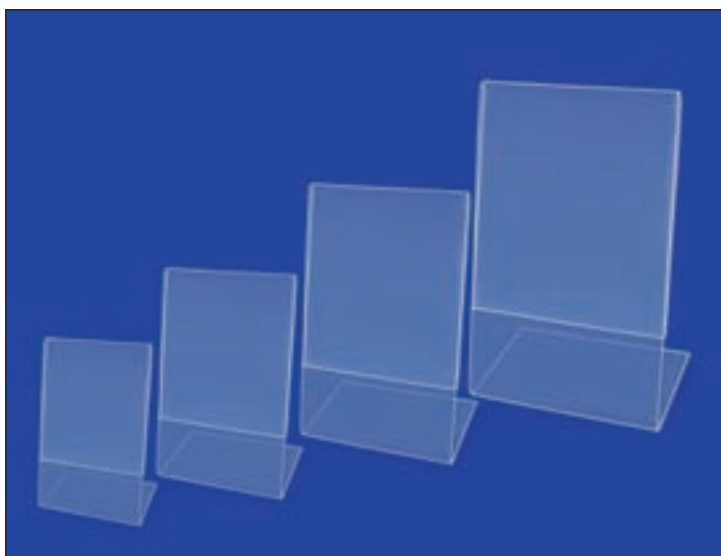

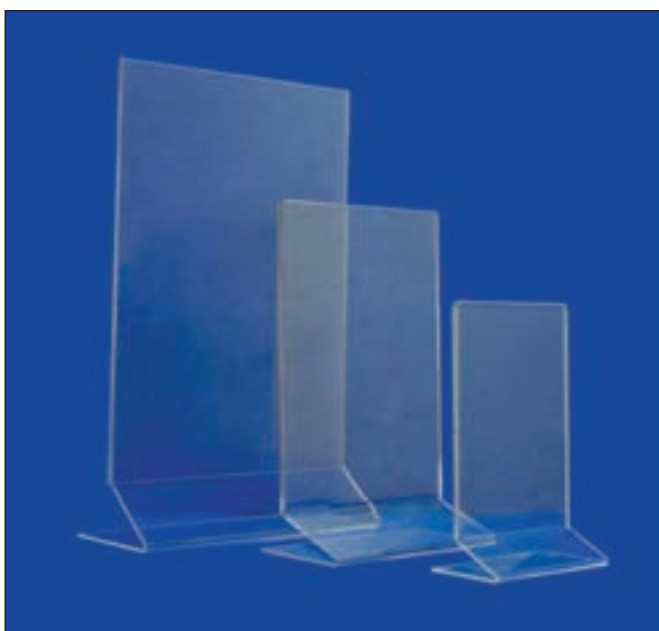

13.004	A3	Pack 10 Uni.
13.005	A4	Pack 10 Uni.
13.006	A5	Pack 10 Uni.
13.007	A6	Pack 10 Uni.

**PORTAGRÁFICA "Z" / PORTE VISUEL EN "Z" / MENU CARD HOLDER "Z" / PORTA-IMPRESSÕES "Z" / ESPOSITORE PIEGATO IN FORMA DI "Z" / Z - STÄNDER / STOJACZEK "Z"**





 Portagráfica en forma de "Z". Fabricadas en metacrilato de 2mm. Tamaños: A4, A5 y A6.

 Porte visuels en forme de "Z". Fabriqué en acrylique de 2mm. Dimensions: A4, A5 e A6.

 Menu card holder "Z". Material: 2mm acrylic. Colour: transparent. Sizes: A4, A5 and A6.

 Porta-impressões em forma de "Z". Fabricada em acrílico de 2mm. Tamanhos: A4, A5 e A6.

 Espositore piegato in forma di "Z". Realizzato in metacrilato di 2mm. Disponibile nei formati A4, A5 e A6.

 Tischständer in Z - Form aus 2mm Acrylglas, in DIN A4, A5 und A6.

 Stojaczek ekspozycyjny na plakat z grafiką. Posiada kształt "Z". Wykonany z plexi o grubości 2mm. Dostępny w formatach: A4, A5, A6.





13.008	A4	Pack 10 Uni.
13.009	A5	Pack 10 Uni.
13.010	A6	Pack 10 Uni.

**PORTAGRÁFICA CON BASE DE MADERA / PORTE VISUELS AVEC SOCLE DE BOIS /  
MENU CARD HOLDER "RECTANGULAR WOOD" / PORTA-IMPRESSÕES COM BASE EM MADEIRA /  
ESPOSITORE QUADRATO CON BASE IN LEGNO / GRAFIKHALTER MIT HOLZFUSS / STOJACZEK Z PODSTAWKĄ Z DRENA**

 Portagráfica con base cuadrada de madera. Fabricadas en metacrilato de 2mm. Tamaños: A4, A5 y A6.

 Porte Brochures avec disposant d'une base en bois de forme carré. Fabriqué en acrylique de 2mm. Disponible en A4, A5, A6.

 Menu card holder "rectangular Wood". Natural wood base. 2mm acrylic insert pocket. Colour: transparent. Sizes: A4, A5 and A6.

 Porta-impressões com base quadrada de madeira. Fabricado em acrílico de 2mm. Tamanhos: A4, A5 e A6.

 Espositore piegato quadrato con base in legno. Realizzati in metacrilato di 2mm. Disponibile nei formati A4, A5 e A6.

 Menühalter aus 2mm Acrylglas mit Holzfuß, in DIN A4, A5 und A6.

 Stojaczek ekspozycyjny na plakat z grafiką. Podstawka z drewna. Wykonany z plexi o grubości 2mm. Dostępny w formatach: A4, A5, A6.

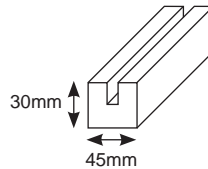
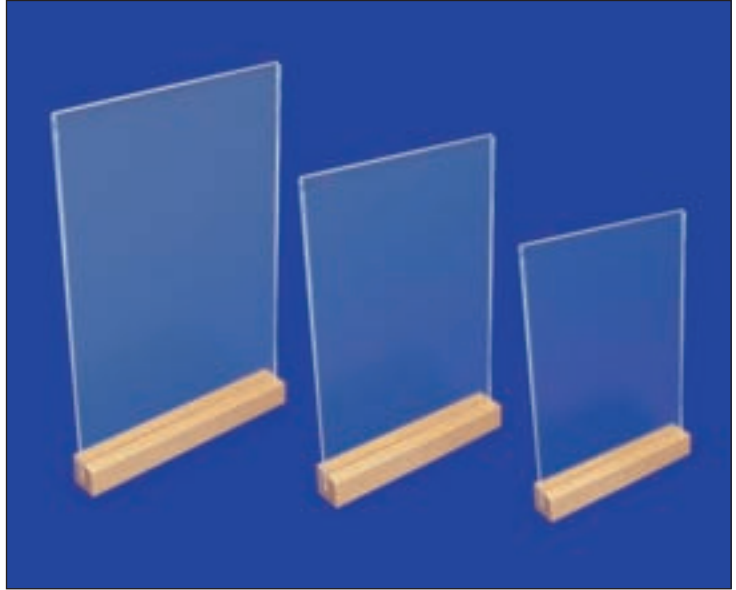

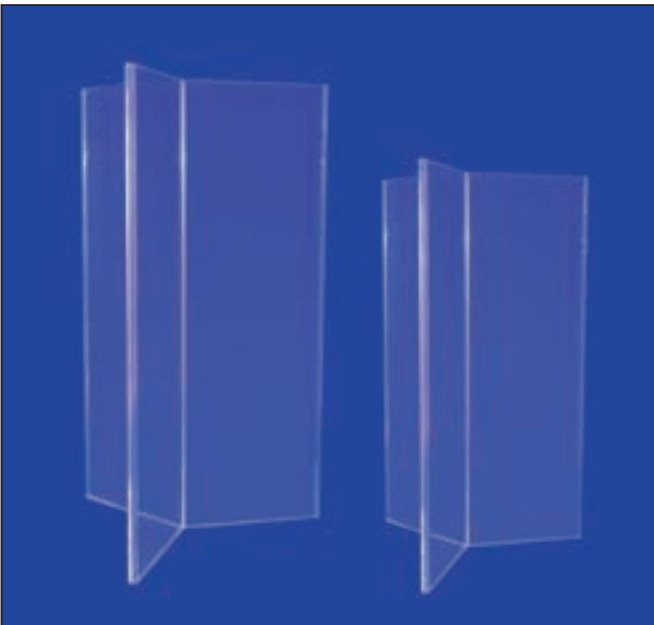

13.011	A4	Pack 10 Uni.
13.012	A5	Pack 10 Uni.
13.013	A6	Pack 10 Uni.

**PORTAGRÁFICA TRES CARAS / PORTE VISUEL DE TROIS FACES / ACRYLIC Y-SHAPED DISPLAY /  
PORTAGRÁFICA TRES CARAS / ESPOSITORE A STELLA / GRAFIKHALTER DREISEITIG / STOJACZEK TRZYSTRONNY**



 Portagráfica de tres caras distribuidas alrededor de un eje central. Fabricadas en metacrilato de 2mm. Tamaños: A4 y A5.

 Porte visuel comprenant trois faces, distribuées autour d'un essieu central. Fabriqué en acrylique de 2mm. Disponible en A4, A5.

 Acrylic Y-Shaped display. Material: 2mm acrylic. Colour: transparent. Sizes: A4 and A5.

 Porta-impressões de três faces distribuídas em torno de um eixo central. Fabricada em acrílico de 2mm. Tamanho: A4 e A5.

 Espositore a stella in metacrilato 2mm. Dimensione inserto 3x4 e 3x5. Colore trasparente.

 Menühalter aus 2mm Acrylglas, für 3 Grafiken, in DIN A4 und A5.

 Stojaczek ekspozycyjny na 3 plakaty z grafiką. Wykonany z plexi o grubości 2mm. Dostępny w formatach: A4, A5.

13.014 A4 Pack 10 Uni.

13.015 A5 Pack 10 Uni.

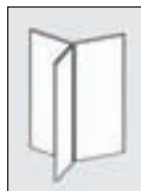



**PORTAGRÁFICA CON PINZA / PORTE VISUELS AVEC PINCE / L-DISPLAY "POSTER SNAP" /  
PORTA-IMPRESSÕES COM PINÇA / ESPOSITORE CON CLIP / KLEMMSTÄNDER / STOJACZEK Z ZACISKIEM**

 Portagráficas con pinza superior. Fabricados en metacrilato de 2mm. Tamaños: A4 y A5. Base imantada.

 Porte visuels disposant d'une pince sur la partie haute et d'un aimant sur la base. Fabriqué en acrylique 2mm. Disponible en A4 et A5.

 L-Display "Poster Snap". Material: 2mm acrylic and aluminium "clip". Magnetic base. Colour: transparent. Sizes: A4 and A5.

 Porta-impressões com pinça superior. Fabricado em acrílico de 2mm. Tamanhos: A4 e A5. Base de íman.

 Espositore in metacrilato 2mm con clip e base magnetica. Disponibile nei formati A4 e A5.

 Tischständer aus 2mm Acrylglas mit oberer Klemmleiste und Magnet - Fuß. In Format DIN A4 und A5.

 Stojaczek ekspozycyjny na plakat z grafiką. Posiada zacisk podtrzymujący grafikę. Wykonany z plexi o grubości 2mm. Podstawka z magnesem. Dostępny w formatach: A4, A5.





13.016 A4 Pack 10 Uni.

13.017 A5 Pack 10 Uni.

**PORTAGRÁFICA CON BASE INDEPENDIENTE / PORTE VISUELS AVEC SOCLE INDEPENDANT /  
MENU CARD HOLDER WITH INDEPENDENT BASE / PORTA-IMPRESSÕES COM BASE INDIPENDENTE /  
EXPOSITORE CON BASATO INDEPENDIENTE / GRAFIKHALTER MIT SEPERATEM FUSS / STOJACZEK Z ZACISKIEM**





 Portagráficas con base independiente. Fabricados en metacrilato de 2mm. Tamaños: A4 y A5.

 Porte visuels avec socle indépendant. Fabriqué en acrylique de 2mm. Dimensions: A4 et A5.

 Menu card holder with independent base. Material: 2mm acrylic. Sizes: A4 and A5. Colour: transparent pocket, clear base.

 Porta-impressões com base independente. Fabricados em acrílico de 2mm. Tamanho: A4 e A5.

 Espositore piegato trasparenti da banco con basato indipendente. Realizzati in metacrilato di 2mm. Disponibile nei formati A4 e A5.

 Tischständer aus 2mm Acrylglas mit separatem Fuß. In Format DIN A4 und DIN A5.

 Stojaczek ekspozycyjny na plakat z grafiką. Posiada zacisk podtrzymujący grafikę. Wykonany z plexi o grubości 2mm. Podstawka z magnesem. Dostępny w formatach: A4, A5.

13.018 A4 Pack 10 Uni.

13.019 A5 Pack 10 Uni.

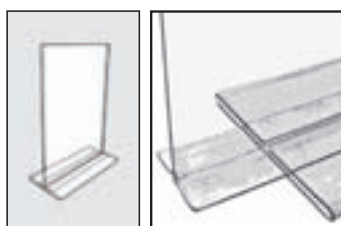



**PORTAGRÁFICA "SANDWICH" / PORTE VISUEL "SANDWICH" / ACRYLIC POCKET "SANDWICH" / PORTA-IMPRESSÕES "SANDWICH" / ESPOSITORE SOSPESA / ACRYLGLASTASCHE / KIESZEŃ EKSPOZYCYJNA**

 Portagráfica para colgar de techo. Fabricadas en metacrilato de 2mm. Tamaños: A1, A2, A3, A4, A5, A6 y 500x700mm.

 Porte visuels "sandwich". Fabriqué en acrylique de 2mm. Dimensions: A1, A2, A3, A4, A5, A6 et 500x700mm.

 Acrylic pocket "sandwich". Material: 2mm acrylic. Colour: transparent. Sizes: A1, A2, A3, A4, A5, A6 and 500x700mm.

 Porta-impressões para pendurar no tecto. Fabricado em acrílico de 2mm. Tamanhos: A1, A2, A3, A4, A5, A6 e 500x700mm.

 Espositore sospeso dal soffitto. Bifacciale, in metacrilato da 2mm a forma di tasca, piegata a "u". Disponibili in diverse formati. A1, A2, A3, A4, A5, A6 y 500x700mm.

 Grafikhalter hängend, aus 2mm Acrylglas. In den Formaten DIN A1 - A6. Abmaße: 500x700mm.

 Kieszeń ekspozycyjna na plakat z grafiką. Do zawieszenia pod sufitem. Wykonana z plexi o grubości 2mm. Dostępna w formatach: A1, A2, A3, A4, A5, A6 oraz 500x700mm.

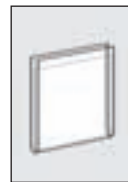
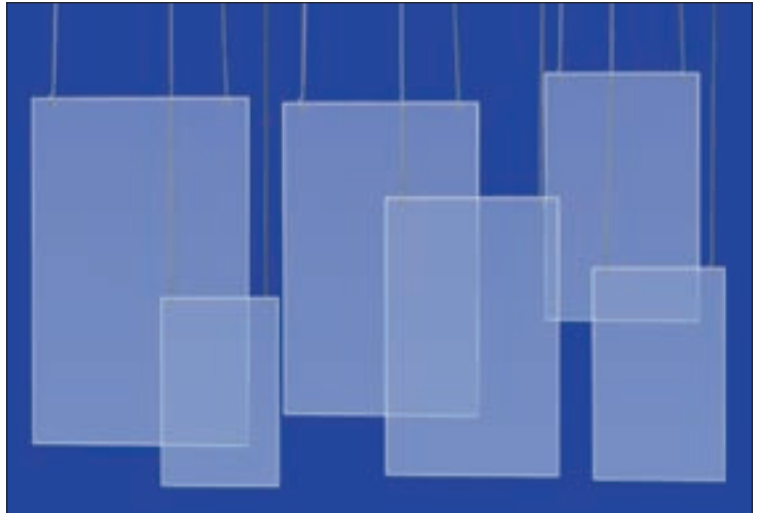

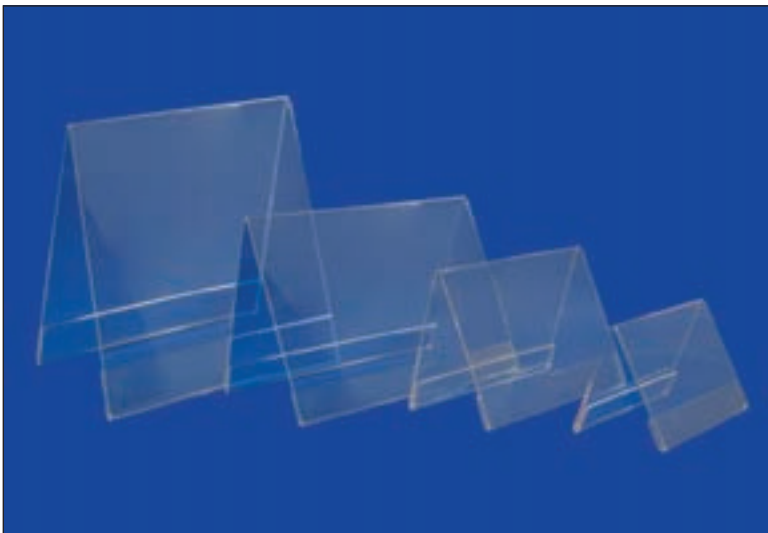

13.020	A1	Pack 10 Uni.
13.021	A2	Pack 10 Uni.
13.022	A3	Pack 10 Uni.
13.023	A4	Pack 10 Uni.
13.024	A5	Pack 10 Uni.
13.025	A6	Pack 10 Uni.
13.026	500x700mm	Pack 10 Uni.

**PORTAGRÁFICA DOBLE CARA / PORTE VISUELS DE DOUBLE FACE / ACRYLIC TENT DISPLAY / PORTA-IMPRESSÕES DUPLA FACE / ESPOSITORE A CAVALLETO / ACRYL - DACHSTÄNDER / STOJACZEK DWUSTRONNY**





 Portagráficas con doble cara horizontal. Fabricadas en metacrilato de 2mm. Tamaños: A4, A5, A6, A7 y 297x105mm.

 Porte visuels horizontaux de double face. Fabriqué en acrylique de 2mm. Dimensions: A4, A5, A6, A7 et 297x105mm.

 Acrylic tent display. With 2 inserts. Material: 2mm acrylic. Colour: transparent. Sizes: A4, A5, A6, A7 and 297x105mm.

 Porta-impressões de dupla face horizontal. Fabricada em acrílico de 2mm. Tamanhos: A4, A5, A6, A7 e 297x105mm.

 Espositore a cavalletto in metacrilato 2mm disponibile in formato A4, A5, A6, A7 e 297x105mm. Colore trasparente.

 Horizontaler Tischständer aus 2mm Acrylglas, doppelseitig. In DIN A4, A5, A6, A7 und 297x105mm.

 Stojaczek ekspozycyjny, dwustronny, poziomy. Wykonany z plexi o grubości 2mm. Dostępny w formatach: A4, A5, A6, A7 oraz 297x105mm.

13.029	A4	Pack 10 Uni.
13.030	A5	Pack 10 Uni.
13.031	A6	Pack 10 Uni.
13.032	A7	Pack 10 Uni.
13.033	297x105mm	Pack 10 Uni.

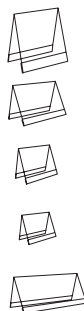

**SOPORTE PORTAGRÁFICA "LUXE" / SUPPORT PORTE VISUELS "LUXE" / MENU CARD HOLDER "LUXE" /  
SOPORTE PORTA-IMPRESSÕES "LUXE" / ESPOSITORE PORTA MESSAGGIO / KLEMMSTÄNDER / PODSTAWKA NA GRAFIKĘ**

 Soporte para portagráficas. Fabricados en poliestireno inyectado.

 Support pour porte visuel. Fabriqué en polystyrène injecté.

 Menu card holder "Luxe". Material: polystyrol. Colour: transparent.

 Suporte para porta-impressões. Fabricados em poliestireno injectado.

 Espositore porta messaggio da banco disponibile nei formati A5. Realizzati in polistirene iniettato.

 Menükarten - Klemme aus Polystyrol.

 Podstawka na grafikę. Wykonana z polistyrenu.



13.034 A5 Pack 10 Uni.



**SOPORTE PORTAGRÁFICA "M" / SUPPORT PORTE VISUELS "M" / MENU CARD HOLDER "M" / SOPORTE PORTA-IMPRESSÕES /  
ESPOSITORE PORTA MESSAGGIO "M" / KLEMMSTÄNDER / PODSTAWKA NA GRAFIKĘ "M"**

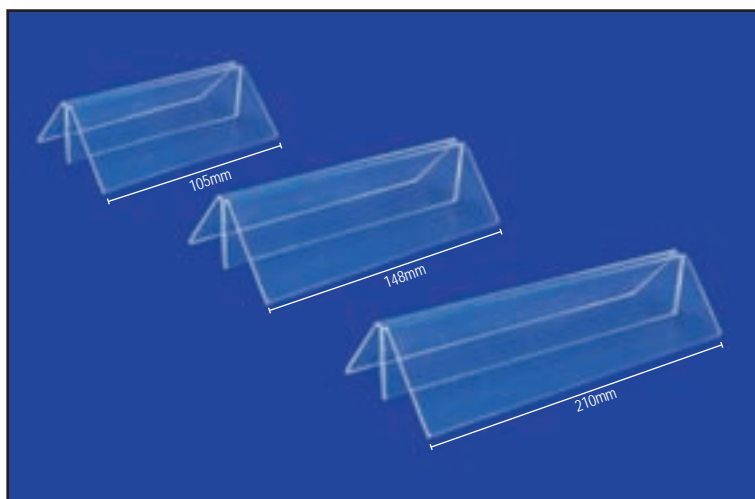



13.035 210mm Pack 10 Uni.

13.036 148mm Pack 10 Uni.

13.037 105mm Pack 10 Uni.

 Soporte para portagráficas en forma de "M". Fabricados en metacrilato de 2mm. Tamaños: A4, A5 y A6.

 Support pour porte visuel en forme de "M". Fabriqué en acrylique de 2mm. Dimension: A4, A5 et A6.

 Menu card holder "M". For cards up to mm thick. Material: 2mm acrylic. Colour: transparent. Size: A4, A5 and A6.

 Suporte para porta-impressões em forma de "M". Fabricado em acrílico de 2mm. Tamanho: A4, A5 e A6.

 Espositore porta messaggio da banco in forma di "M". Realizzato in metacrilato di 2mm. Disponibile nei A4, A5 e A6.

 Menükarten - Klemme in M - Form aus 2mm Acrylglas. In DIN A4, A5 und A6.

 Podstawka na grafikę w formie "M". Wykonana zplex i o grubości 2mm. Wymiary: A4, A5, A6.

**PORTAGRÁFICA BASE TRAPECIO / PORTE BROCHURE BASE TRAPEZE / MENU CARD HOLDER "TWO PARTS" / PORTA-IMPRESSÕES COM BASE TRAPÉZIO / PORTABIGLIETTI / GRAFIKHALTER MIT TRAPEZFUSS / STOJACZKI EKSPOZYCYJNE**

 Portagráficas realizadas en poliestireno inyectado. La gráfica queda cubierta por su parte anterior y posterior, permitiendo su uso a doble cara. Disponible en varios tamaños.

 Porte-brochure fabriqué en polystyrène injecté. Le visuel est couvert recto-verso ce qui permet l'usage en double face. Disponible en plusieurs dimensions.

 Menu card holder "Two parts". One or double sided use.

 Porta-impressões fabricado em poliestireno injectado. A impressão fica coberta quer da parte dianteira quer da parte traseira, permitindo o uso de dupla face. Disponível em vários tamanhos.

 Portabiglietti in polistireno iniettato trasparente, bifacciale. Disponibili in diversi formati. Per organizzare ogni spazio e adattarsi a qualsiasi ambiente. Disponibile in diverse dimensioni.

 Tischständer aus Polystyrol, doppelseitige Nutzung möglich. Grafik wird von Vorder- und Rückseite umschlossen. Verfügbar in verschiedenen Größen.

 Stojaczek ekspozycyjny z podstawką w formie trapezu. Dwustronny. Wykonany z polistyrenu. Do dyspozycji w wielu formatach.

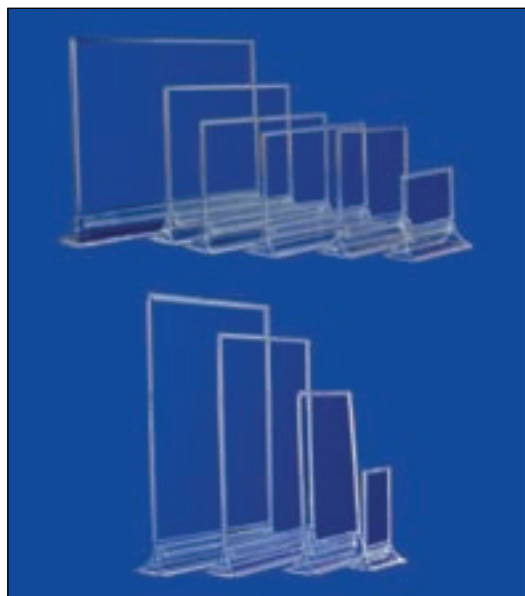

13.075	55x90mm	Pack 10 Uni.
13.079	120x180mm	Pack 10 Uni.
13.081	180x250mm	Pack 10 Uni.
13.083	210x297mm	Pack 10 Uni.

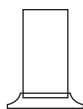



13.074	90x55mm	Pack 10 Uni.
13.076	180x100mm	Pack 10 Uni.
13.077	120x100mm	Pack 10 Uni.
13.078	210x110mm	Pack 10 Uni.
13.080	210x150mm	Pack 10 Uni.
13.082	297x210mm	Pack 10 Uni.

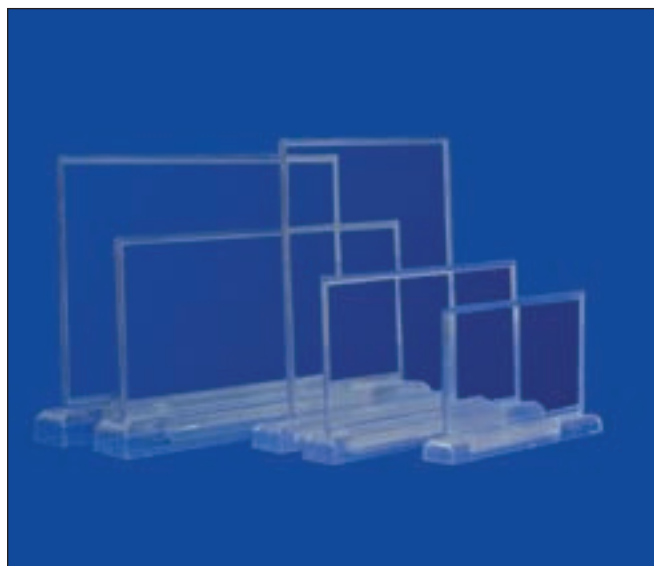

**PORTAGRÁFICA BASE RECTANGULAR / PORTE BROCHURES DE BASE RECTANGULAIRE / MENU CARD HOLDER RECTANGULAR BASE / PORTA-IMPRESSÕES COM BASE RECTÂNGULAR / PORTABIGLIETTI RECTANGOLARE / GRAFIKHALTER MIT RECHTECKIGEM FUSS / STOJACZEK Z PODSTAWKĄ**





 Portagráficas realizado en poliestireno inyectado. La gráfica queda cubierta por su parte anterior y posterior, permitiendo su uso a doble cara. Disponible en varios tamaños.

 Porte Brochure fabriqué en polystyrène injecté. L'impression est couverte en recto-verso ce qui permet l'usage en double face. Disponible en plusieurs dimensions.

 Menu card holder rectangular base. One or double sided use.

 Porta-impressões fabricados em poliestireno injectado. A imagem fica coberta pela frente e pelo verso, permitindo o uso de dupla face. Disponível em vários tamanhos.

 Portabiglietti in polistireno iniettato trasparente, bifacciale. Disponibili in diversi formati. Per organizzare ogni spazio e adattarsi a qualsiasi ambiente. Disponibile in diverse dimensioni.

 Tischständer aus Polystyrol, doppelseitige Nutzung möglich. Grafik wird von Vorder- und Rückseite umschlossen. Verfügbar in verschiedenen Größen.

 Stojaczek ekspozycyjny z podstawką. Dwustronny. Wykonany z polistyrenu. Do dyspozycji w wielu formatach.

13.084	150x90mm	Pack 10 Uni.
13.086	190x100mm	Pack 10 Uni.
13.088	260x120mm	Pack 10 Uni.
13.089	260x175mm	Pack 10 Uni.

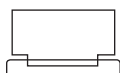

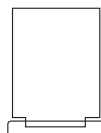

13.085	120x160mm	Pack 10 Uni.
13.087	170x210mm	Pack 10 Uni.





**PORTAGRÁFICA CON BASE PLEGABLE / PORTE BROCHURE DE BASE PLIABLE / MENU CARD HOLDER "FOLDING" / PORTA-IMPRESSÕES COM BASE DOBRÁVEL / PORTABIGLIETTI BASE PIEGHEVOLE / GRAFIKHALTER MIT TRAPEZFUSS / STOJACZEK Z PODSTAWKĄ SKŁADANĄ**

 Portagráficas realizadas en poliestireno inyectado. Base plegable. Disponible en varios tamaños.

 Porte brochure fabriqué en polystyrène injecté. Base pliable. Disponible en plusieurs dimensions.

 Menu card holder "Folding". Material: Polystyrol.

 Porta-impressões fabricados em poliestireno injectado. Base dobrável. Disponível em vários tamanhos.

 Portabiglietti realizzati in polistireno iniettato. Base pieghevole. Disponibile in diverse dimensioni.

 Grafikhalter aus Polystyrol mit klappbarem Fuß. Verfügbar in verschiedenen Größen.

 Stojaczek ekspozycyjny z podstawką składaną. Wykonany z polistyrenu. Do dyspozycji w wielu formatach.

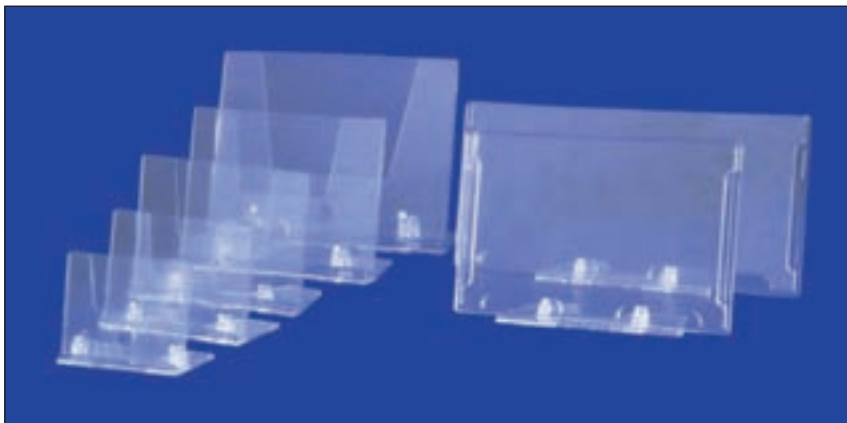

13.095	64x46mm	Pack 10 Uni.
13.091	80x53mm	Pack 10 Uni.
13.090	100x68mm	Pack 10 Uni.
13.093	120x80mm	Pack 10 Uni.
13.096	155x105mm	Pack 10 Uni.
13.092	192x86mm	Pack 10 Uni.
13.094	142x86mm	Pack 10 Uni.

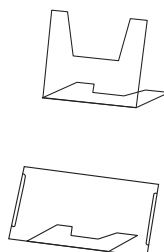



**PORTACATÁLOGOS CON ANILLAS / PORTE CATALOGUES AVEC DES ANNEAUX / L-DISPLAY WITH RING BINDER / PORTA-CATÁLOGOS COM ARGOLAS / PORTADEPLIANTS CON ANELLI / GRAFIKHALTER MIT RINGBINDUNG / STOJACZEK Z MECHANIZMEM PIERŚCIENIOWYM**



 Portacatálogos con anillas. Fabricados en metacrilato de 3mm. Tamaño: A4 + A4.

 Porte catalogues avec des anneaux. Fabriqué en acrylique de 3mm. Dimension: A4+A4.

 For A4 portrait sheets with 4 perforations. Material: 3mm acrylic. Colour: Transparent. Size: A4+A4.

 Porta-catálogos com argolas. Fabricado em acrílico de 3mm. Tamanho: A4+A4.

 Portadepliants in metacrilato trasparente, dotato di sistema di aggancio delle stampe a anelli, con quattro fori di ingresso. Spessore del metacrilato: 3mm. Dimensioni : A4+A4.

 Grafikhalter aus 3mm Acrylglas mit Ringbindung. In Format DIN A4 und DIN A4.

 Stojaczek ekspozycyjny z mechanizmem pierścieniowym. Wykonany z plexi o grubości 3mm. Do dyspozycji w formatach: A4+A4.

13.043	A4+A4	Pack 5 Uni.
--------	-------	-------------

**SOPORTE PORTAMONEDAS ACRÍLICO / SUPPORT PORTE MONNAIE D'ACRYLIQUE / CASH CADDIE /  
SOPORTE PARA PORTA-MOEDAS ACRÍLICO / SUPPORTE PER MONETA / ZAHLTELLER / PODSTAWKA NA PIENIĄDZE**

 Soporte para portamonedas al que se puede acoplar una gráfica de publicidad de tamaño 161x160mm.

 Support porte-monnaie sur lequel on peut y placer une image publicitaire de 161x160mm.

 With 4 rubber feet to prevent slipping. Material: plastic. Colour: clear. Format: 161x160mm.

 Suporte para porta-moedas ao qual se pode juntar uma imagem de publicidade de tamanho 161x160mm.

 Supporte per moneta con 4 piedini antiscivolo. Permette inserire grafica pubblicitaria 161x160mm.

 Zahlteiler mit austauschbarem Werbeeinleger 161x160mm.

 Podstawka na pieniądze. Możliwość zamieszczenia grafiki reklamowej. Powierzchnia na grafice: 161x160mm.

10.761 210x175mm

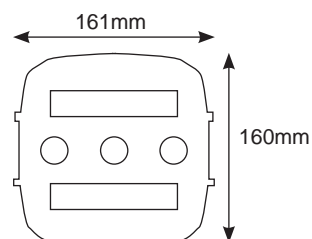

**SOPORTE GIRATORIO ACRÍLICO / SUPPORT GIRATOIRE ACRYLIQUE / REVOLVING DISPLAY / SUPORTE GIRATÓRIO ACRÍLICO / SUPPORTO ROTANTE IN ACRILICO / DREHBARER GRAFIKHALTER / PODSTAWKA OBROTOWA**





13.072 Ø 140mm

 Soporte acrílico giratorio. Ideal para la realización de displays.

 Support giratoire en acrylique. Idéal pour la création d'un display.

 Revolving display base.

 Suporte em acrílico giratório. Ideal para a realização de displays.

 Supporto rotante in acrilico. Ideale per la costruzione di display.

 Drehkranz zur Präsentation von Grafiken.

 Podstawka prezentacyjna, obrotowa. Wykonana z plexi.

### MENUBOOK

 Menubook de sobremesa o suelo. Incluye 10 sobres plásticos tamaño A4.

 Menubook à poser sur une table ou au sol. Inclus 10 pochettes plastiques de format A4.

 Wire Docuholders. Chromed metal literature holders. Rubber feet protect countertop surfaces.

 Menubook de mesa ou chão. Inclui 10 micas em plástico tamanho A4.



 Espositore a leggido da banco o da piano con 10 tasche A4. Veloce e facile da montare. Ideale per esporre grandi quantità di informazioni.

 Präsentationsständer für Tisch oder Boden. Inklusive 10 Kunststoffaschen DIN A4.

 Przeglądarka. Posiada 10 kieszonek A4 wykonanych z plastiku. Dwa rodzaje przeglądarek: na stół i na podłogę.



13.122

QTY.			CBM	x 	z
Uni.	1	1.90	2.15	0.012	360X340X100

13.122 A4 "Black"





13.123

QTY.			CBM	x 	z
Uni.	1	5.20	5.40	0.018	345x345x155

13.123 A4 "Black"

**PORTACATÁLOGOS SIMPLE / PORTE CATALOGUES SIMPLE / SINGLE WALL-MOUNTED OR DESK DISPENSER /  
PORTA-CATÁLOGOS SIMPLES / PORTA CATALOGUI DA MURO / PROSPEKTHALTER SCHLICHT / POJEMNIK PROSTY**

 Portacatálogos simple, para su uso en sobremesa o en pared. Fabricados en poliestireno. Tamaños: A4, A5 y A6.

 Porte catalogue simple que l'on peut poser sur une table ou fixer au mur. Fabriqué en polystyrène. Disponible en A4, A5, A6.

 Single wall-mounted or desk dispenser. Material: polystyrol. Colour: transparent. Sizes: A4, A5 and A6.

 Porta-catálogos simples para usar sob a mesa e numa parede. Fabricados em poliestireno. Tamanhos: A4, A5 e A6.

 Porta cataloghi da muro e da banco realizzati in polistirene trasparente. Disponibili in formati A4, A5 e A6.

 Prospekthalter aus Kunststoff für Tisch oder Wand. Format in DIN A4, A5 und A6.

 Prosty pojemnik na prospekty. Do ustawienia na biurku, lub do zamocowania na ścianie. Wykonany z polistyrenu. Dostępny w wymiarach; A4, A5, A6.

13.038 A4 Pack 10 Uni.

13.039 A5 Pack 10 Uni.

13.040 A6 Pack 10 Uni.

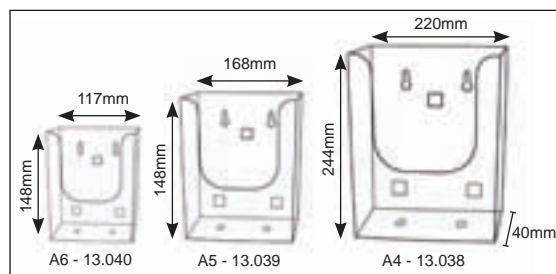
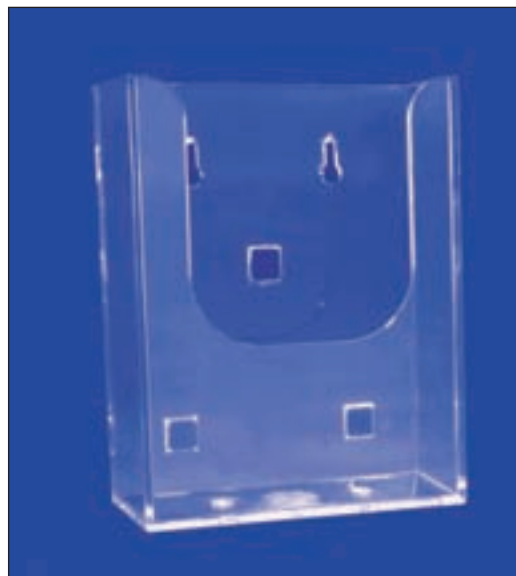

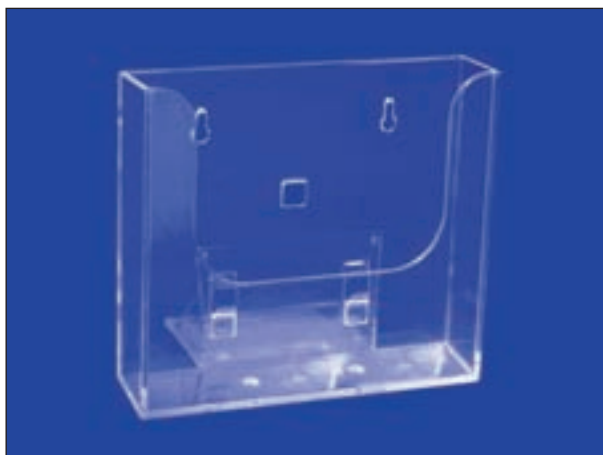

**PORTACATÁLOGOS CON PEANA / PORTE CATALOGUES AVEC SOCLE / SINGLE WALL-MOUNTED DISPENSER /  
PORTA-CATÁLOGOS COM APOIO / PORTA CATALOGHI CON PIEDINE / PROSPEKTHALTER MIT FUSS / POJEMNIK Z PODPÓRKĄ**





 Portacatálogos con peana trasera desmontable, para su uso en sobremesa o en pared. Fabricados en poliestireno. Tamaños: A4, A5 y A6.

 Porte catalogue disposant d'un socle arrière pliant pour l'utiliser sur une table, possibilité de le fixer au mur. Fabriqué en polystyrène. Disponible en A4, A5, A6.

 Single Wall-Mounted Dispenser. With 2 screw holes for wall-mounting and attachment for standing. Material: polystyrol. Colour: transparent. Sizes: A4, A5 and A6.

 Porta-catálogos com apoio traseiro desmontável para usar sob a mesa ou na parede. Fabricados em poliestireno. Tamanhos: A4, A5 e A6.

 Porta cataloghi da muro e da banco realizzati in polistirene trasparente, con piedine di sostegno smontabile. Disponibili in formati A4, A5 e A6.

 Prospekthalter aus Kunststoff mit abnehmbarem Fuß, für Tisch oder Wand. In DIN A4, A5 und A6.

 Pojemnik na prospekty z podpórką. Podpórka demontowana. Do ustawienia na biurku, lub do zamocowania na ścianie. Wykonany z polistyrenu. Dostępny w wymiarach; A4, A5, A6.

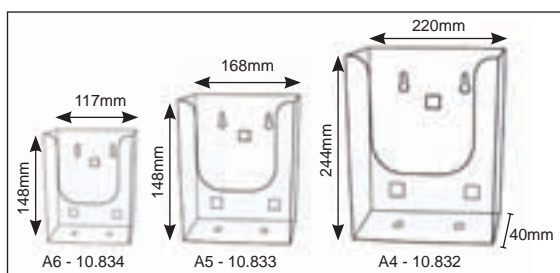



10.832 A4 Pack 10 Uni.

10.833 A5 Pack 10 Uni.

10.834 A6 Pack 10 Uni.

**PORTACATÁLOGOS CON VENTOSAS / PORTE CATALOGUES AVEC VENTOUSES /  
SINGLE WALL-MOUNTED DISPENSER WITH SUCTION / PORTA-CATÁLOGOS COM VENTOSAS /  
PORTA CATALOGHI CON VENTOSE / PROSPEKTHALTER MIT SAUGNÄPFEN / POJEMNIK Z PRZYSSAWKAMI**

 Portacatálogos con ventosas, para su uso en cristales, escaparates, etc. Fabricados en poliestireno. Tamaños A4 (4 ventosas), A5 y A6 (3 ventosas).

 Porte catalogue comprenant des ventouses, permettant de l'accrocher aux vitres, vitrines, etc. Fabriqué en polystyrène. Disponible en A4 (4 ventouses), en A5 et A6 (3 ventouses).

 Single wall-mounted dispenser with suction cup. Material: polystyrol. Colour: transparent. Sizes: A4, A5 and A6.

 Porta-catálogos com ventosas para usar em vidros, montras, etc. Fabricados em poliestireno. Tamanhos A4 (4 ventosas), A5 e A6 (3 ventosas).

 Porta cataloghi con ventose. Realizzati in polistirene. Disponibile in A4 (4 ventose), A5 e A6 (3 ventose).

 Prospekthalter aus Kunststoff mit Saugnäpfhalterung für Glasscheiben, Schaufenster etc. Format in DIN A4 (4 Saugnäpfe), A5 und A6 (3 Saugnäpfe).

 Pojemnik na foldery z przyssawkami. Mocowany do powierzchni szklanych, PVC, etc. Format A4 zawiera 4 przyssawki. Formaty A5 i A6 zawierają trzy przyssawki. Wykonany z polistyrenu.

10.835 A4 Pack 10 Uni.

10.836 A5 Pack 10 Uni.

10.837 A6 Pack 10 Uni.

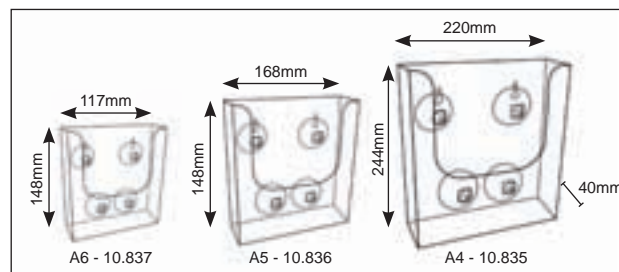

**PORTACATÁLOGOS CON CAJETÍN / PORTE CATALOGUES AVEC COMPARTIMENT / L-DISPLAY WITH 1/3 A4  
LEAFLET DISPENSER / PORTA-CATÁLOGOS COM COMPARTIMENTO / PORTADEPLIANTS CON PORTAPOSTER /  
L-DISPLAY MIT PROSPEKTHALTER / STOJACZEK EKSPOZYCYJNY Z KIESZONKĄ**





 Portacatálogos con cajetín para colocar publicidad. Fabricados en metacrilato de 3mm el A3, y en metacrilato de 2mm el A4. Tamaños: A3 y A4.

 Porte brochure comprenant un compartiment pour y placer de la publicité. Fabriqué en acrylique de 3mm pour le A3, 2 mm pour le A4.

 L-Display with 1/3 A4 leaflet dispenser adhered to right. Colour: transparent. Material: 3mm acrylic for A3 and 2mm acrylic for A4.

 Porta-catálogos com compartimento para colocar publicidade. Fabricados em acrílico de 3mm o tamanho A3, e em acrílico de 2mm o tamanho A4. Tamanhos: A3 e A4.

 Portadepliants da banco con portaposter. Realizzato in metacrilato di 3mm il A3 e in metacrilato di 2 mm il A4.

 L-Display aus Kunststoff mit Prospekthalter für Info-Broschüren. Format in DIN A4 mit 2mm Stärke und DIN A3 mit 3mm Stärke.

 Stojaczek ekspozycyjny z kieszonką na umieszczenie materiałów reklamowych. Wykonany z plexi: A3 - grubość 3mm, A4 - grubość 2mm.

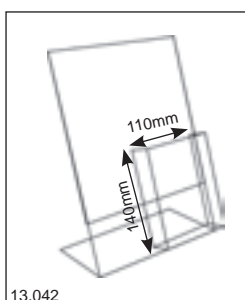



13.042

13.041 A3 Pack 5 Uni.

13.042 A4 Pack 5 Uni.

PORTACATÁLOGOS / PORTE-BROCHURES / LITERATURE HOLDER / PORTA-CATÁLOGOS /  
PORTADEPLIANTS / PROSPEKTHALTER / STOJACZKI EKSPOZYCYJNE

 Portacatálogos para uso en sobremesa o pared. Tamaño 1/3 A4.

 Porte-brochures à poser ou à fixer au mur. Dimensions: 1/3 de A4.

 Literature Holder for countertop or wallmount use. Size 1/3 A4.

 Porta-catálogos para usar sobre mesas ou na parede. Tamanho 1/3 A4.

 Portadeplianti per il suo uso da banco o parete. Dimensione: 1/3 A4.

 Prospekthalter aus Kunststoff für Tisch oder Wand, mit 1 - 3 Fächern in DIN A4.

 Stojaczki na katalogi w formacie A4. Do ustawienia na biurku, lub zawieszenia na ścianie. Do dyspozycji trójprzegrodowe, dwuprzegrodowe oraz jednoprzegrodowe.





13.103	1x 1/3 A4	Pack 6 Uni.
13.104	2x 1/3 A4	Pack 6 Uni.
13.105	4x 1/3 A4	Pack 4 Uni.

PORTACATÁLOGOS / PORTE-BROCHURES / LITERATURE HOLDER / PORTA-CATÁLOGOS /  
PORTADEPLIANTS / PROSPEKTHALTER / STOJACZKI EKSPOZYCYJNE





 Portacatálogos para uso en sobremesa o pared. Tamaño A5.

 Porte-brochures à poser ou à fixer au mur. Dimensions: A5.

 Literature Holder for countertop or wallmount use. Size A5.

 Porta-catálogos para usar sobre mesas ou na parede. Tamanho A5.

 Portadeplianti per il suo uso da banco o parete. Dimensione A5.

 Prospekthalter aus Kunststoff für Tisch oder Wand. Format in DIN A5.

 Stojaczki na katalogi w formacie A5. Do ustawienia na biurku, lub zawieszenia na ścianie. Do dyspozycji trójprzegrodowe, dwuprzegrodowe oraz jednoprzegrodowe.

13.106 1xA5 Pack 8 Uni.

13.107 2xA5 Pack 5 Uni.

13.108 4xA5 Pack 4 Uni.





PORTACATÁLOGOS / PORTE-BROCHURES / LITERATURE HOLDER / PORTA-CATÁLOGOS /  
PORTADEPLIANTS / PROSPEKTHALTER / STOJACZKI EKSPOZYCYJNE

 Portacatálogos para uso en sobremesa o pared. Tamaño A4.

 Porte-brochures à poser ou à fixer au mur. Dimensions: A4.

 Literature Holder for countertop or wallmount use. Size 4.

 Porta-catálogos para usar sobre mesas ou na parede. Tamanho A4.

 Portadeplianti per il suo uso da banco o parete. Dimensione A4.

 Prospekthalter aus Kunststoff für Tisch oder Wand. Format in DIN A4.

 Stojaczki na katalogi w formacie A4. Do ustawienia na biurku, lub zawieszenia na ścianie.





	13.109	1xA4	Pack 7 Uni.
	13.110	2xA4	Pack 4 Uni.
	13.111	3xA4	Pack 2 Uni.

PORTACATÁLOGO SOBREMESA / PORTE-BROCHURE À POSER / LITERATURE HOLDER FOR COUNTERTOP /  
PORTA-CATÁLOGO SOBRE MESA / PORTADEPLIANTS DA BANCO / TISCH-PROSPEKTHALTER /  
STOJACZEK OBROTOWY NA PROSPEKTY



 Portacatálogos giratorio tres caras. Colores: Blanco o Negro. Tamaño A4.

 Porte-brochures giratoire à 3 faces. Coloris: Blanc et noir. Dimensions: A4.

 Rotating literature holders. Three-sided units have clear pockets for easy viewing. Colours: Black or white. Size A4.

 Porta-catálogos giratório com 3 faces. Cores disponíveis: branco ou preto. Tamanho A4.

 Portadeplianti trifacciale girevole. Colore bianco o nero. A4.

 Dreiseitiger, drehbarer Prospekthalter aus Kunststoff, in den Farben Schwarz oder Weiß. Format in DIN A4.

 Trójstronny stojaczek obrotowy na foldery w formacie A4. Kolory: czarny lub biały.

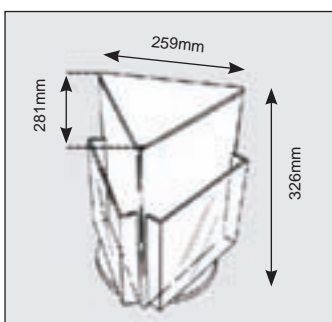

13.115 A4 "White"

13.116 A4 "Black"

**BUZÓN CON SOPORTE PUBLICIDAD / BOÎTE POUR L'EXTÉRIEUR / OUTDOOR LITERATURE BOX / CAIXA DE CORREIO PARA EXTERIOR / PORTADEPLIANT ESTERNI / BRIEFKASTEN MIT GRAFIKFLÄCHE / SKRZYŃKA NA DOKUMENTY**

 Buzón o portadocumentos para exterior. Posibilidad de colocar una gráfica.

 Boîte aux lettres ou porte documents pour l'extérieur. Possibilité d'insérer un visuel.

 Break-resistant and weatherproof. Fits a variety of poles and posts. Clear box with black lid.

 Caixa de correio o porta documentos para exterior. Posibilidade de colocar impressão.

 Portadepliant (cassetta della posta) per la parte esterna. Permette mettere una grafica.

 Briefkasten bzw. Prospektbox mit integrierter Grafikfläche, für Outdoor Bereich.

 Skrzynka na dokumenty. Do użytku zewnętrznego. Możliwość umieszczenia grafiki.



QTY.	KG NW	KG GW	CBM	x y z	
Uni.	1	0.6	0.8	0.013	270X350X140
13.125					

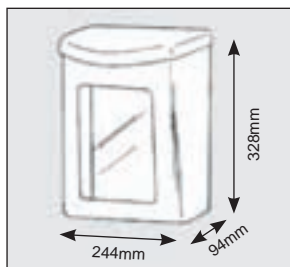

**SOPORTE DE DOCUMENTOS A PARED / SUPPORT POUR DOCUMENTS AU MUR / WALL POCKET LANDSCAPE OR PORTRAIT / SOPORTE DE DOCUMENTOS PARA PAREDE / SUPPORTI DI DOCUMENTI A PARETE / WAND-PROSPEKTHALTER / POJEMNIK NA DOKUMENTY**





 Soporte de documentos a pared. Horizontal o Vertical. Tamaño A4.

 Porte documents à fixer au mur. Disponible en A4 Horizontal ou vertical.

 Wall pocket landscape or portrait. Size A4.

 Suporte de documentos para parede. Horizontal ou Vertical. Tamanho A4.

 Supporti di documenti a parete. Orizzontale o Verticale. Dimensione A4.

 Prospekthalter für die Wand. Modelle für horizontale oder vertikale Nutzung. Format in DIN A4.

 Pojemnik na dokumenty; do zawieszenia na ścianie. Pionowy lub poziomy. Format A4.

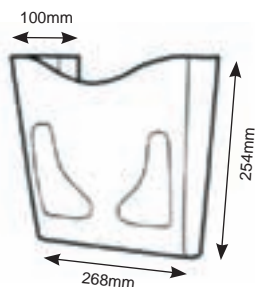

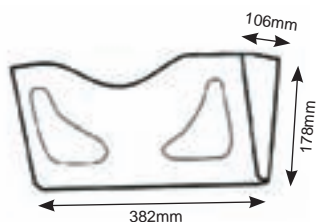

QTY.	KG NW	KG GW	CBM	x y z	
Uni.	1	0.32	0.52	0.008	270X270X115
13.126					





QTY.	KG NW	KG GW	CBM	x y z	
Uni.	1	0.30	0.50	0.009	405X200X115
13.127					

PORTACATÁLOGOS A PARED / PORTE CATALOGUES DE MUR / WALL-MOUNTED LEAFLET DISPENSER / PORTA-CATÁLOGOS DE PAREDE / PORTADEPLIANT DA PARETE / WAND-PROSPEKTHALTER / ŚCIENNY POJEMNIK NA PROSPEKTY

 Portacatálogos para pared con varios cajetines. Fabricados en poliestireno. Tamaños para catálogos A4 y A5. Se suministran en cajas individuales.

 Porte catalogues à fixer au mur comprenant plusieurs compartiments. Fabriqué en polystyrène. Possibilité de placer des catalogue A4 et A5.

 Wall-Mounted leaflet dispenser. For 3XA4 leaflets. For 4XA5 leaflets.

 Porta-catálogos para colocar na parede com várias divisórias. Fabricados em poliestireno. Tamanhos para catálogo A4 e A5. Distribuem-se em caixas individuais.

 Portadepliant da parete con supporto e frontalino. Vaschette trasparenti. In 2 formati. Misure per cataloghi A4 e A5.

 Prospekthalter aus Kunststoff zur Wandbefestigung. Format in DIN A4 und DIN A5.

 Ścienny, trójprzegrodowy pojemnik na prospekty w formacie A4 i A5. Wykonany z polistyrenu.



13.044



13.045

13.044 3xA4

13.045 4xA5

PORTACATÁLOGOS A PARED / PORTE CATALOGUES DE MUR / WALL-MOUNTED LEAFLET DISPENSER / PORTA-CATÁLOGOS DE PAREDE / PORTADEPLIANT DA PARETE / WAND-PROSPEKTHALTER / ŚCIENNY POJEMNIK NA PROSPEKTY

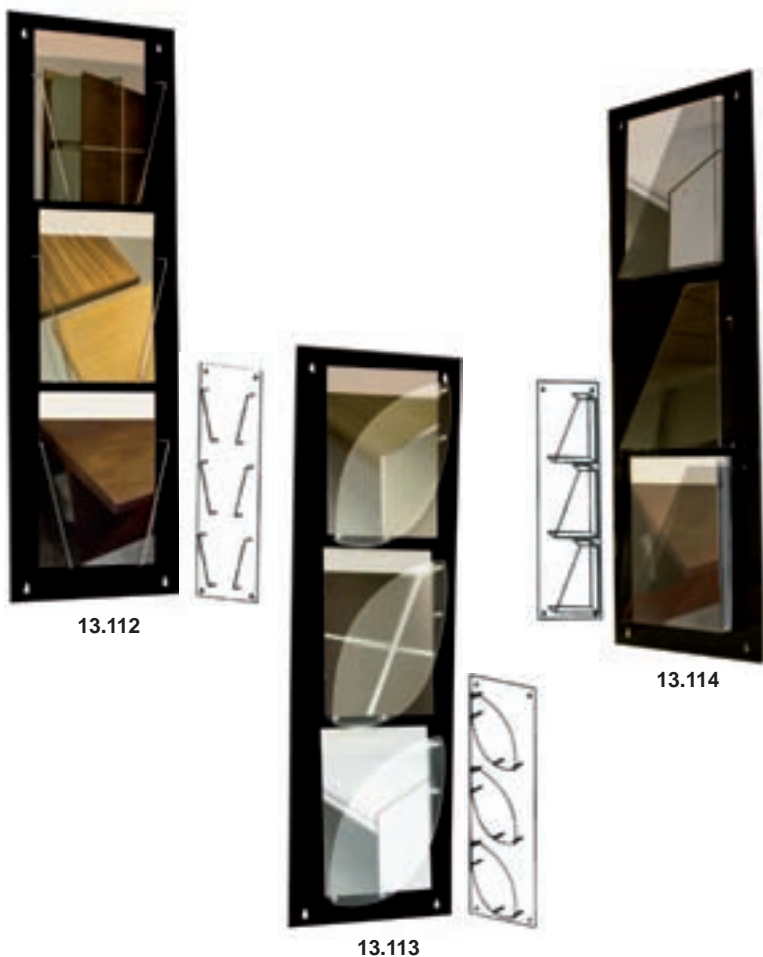



13.112

13.114

13.113

 Portacatálogos para uso de pared. Tamaño A4.

 Porte-brochures à fixer au mur. Dimensions: A4.

 Wall Mount Literature Display. Pockets are preassembled to a black back panel. Size A4.

 Porta-catálogos para usar na parede. Tamanho A4.

 Portadepliant da parete. Dimensione A4.

 Prospekthalter zum Befestigen an der Wand. Format in DIN A4.

 Ścienny pojemnik na prospekty w formacie A4.

13.112 A4 "Line" 320x1009mm

13.113 A4 "Oval" 320x1009mm

13.114 A4 "Flash" 320x1009mm

ACRYLIC DISPLAY

 Soporte acrílico inclinado. 2mm.

 Support acrylique incliné. 2mm.

 Acrylic easel. 2mm.

 Suporte inclinado de acrílico. 2mm.

 Supporto inclinato in acrílico. 2mm.

 Präsentationsständer aus Acryl. 2mm.

 Akrylowa podstawka ekspozycyjna. 2mm.

50.300 200x50mm Pack 5 Uni.

50.301 100x60mm Pack 5 Uni.

50.302 140x40mm Pack 5 Uni.

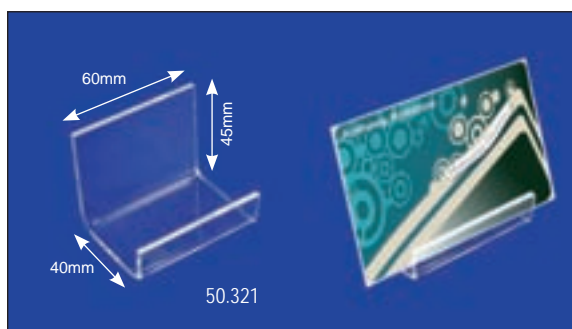
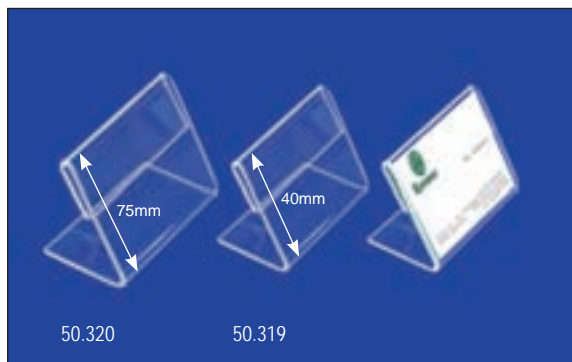
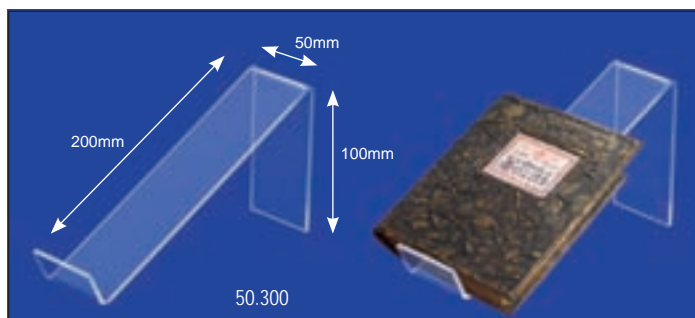
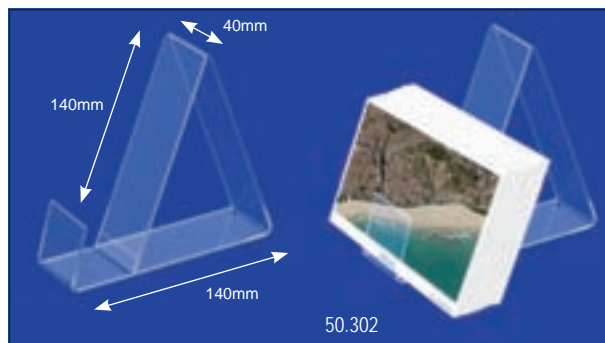
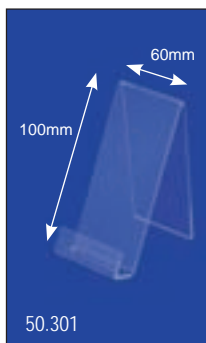

ACRYLIC DISPLAY

 Soporte acrílico para tarjetas. 2mm.

 Support acrylique pour cartes de visite. 2mm.

 Business card holders. 2mm.

 Suporte de acrílico para a colocação de cartões. 2mm.

 Supporto per carte da visita, in acrílico. 2mm.

 Visitenkartenhalter aus Acryl. 2mm.

 Akrylowy stojaczek na wizytówki. 2mm.

50.319 50x40mm Pack 10 Uni.

50.320 105x75mm Pack 10 Uni.

50.321 60x45x40mm Pack 10 Uni.

ACRYLIC DISPLAY

 Escalera acrílica de 2 peldaños. 3mm.

 Escalier acrylique de 2 marches. 3mm.

 Acrylic narrow 2 steps stand. 3mm.

 Expositor em acrílico com dois níveis. 3mm.

 Display in scala di 2 gradini, in acrilico. 3mm.

 Präsentationstreppe aus Acryl mit 2 Stufen. 3mm.

 Ekspozytor akrylowy, dwupoziomowy. 3mm.

50.306 100x100x210mm Pack 5 Uni.

50.307 200x100x210mm Pack 5 Uni.

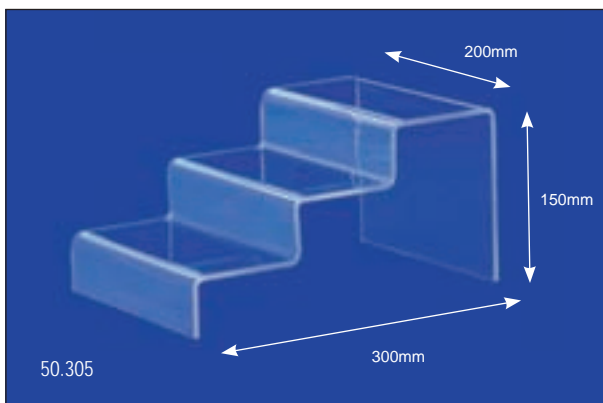
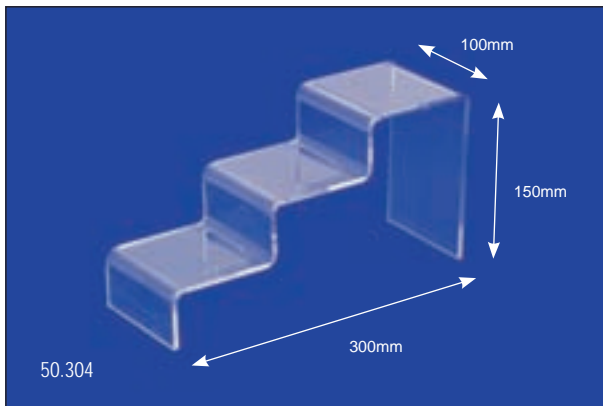
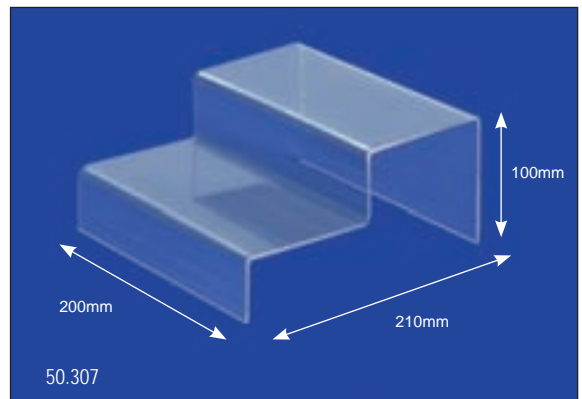
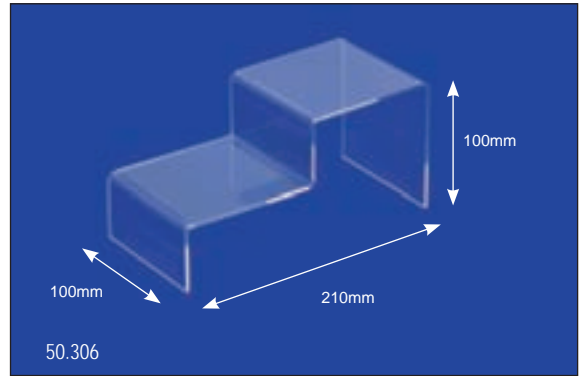



ACRYLIC DISPLAY

 Escalera acrílica de 3 peldaños. 3mm.

 Escalier acrylique de 3 marches. 3mm.

 Acrylic narrow 3 steps stand. 3mm.

 Expositor em acrílico com 3 níveis. 3mm.

 Display in scala di 3 gradini, in acrilico. 3mm.

 Präsentationstreppe aus Acryl mit 3 Stufen. 3mm.

 Ekspozytor akrylowy, trójpoziomowy. 3mm.

50.304 100x150x300mm Pack 5 Uni.

50.305 200x150x300mm Pack 5 Uni.

### ACRYLIC DISPLAY



Podium acrílico. 3mm.



Podium acrylique. 3mm.



Narrow podium. 3mm.



Expositor em acrílico em forma de pódio. 3mm.



Display-podio, in acrilico. 3mm.



Präsentationspodium aus Acryl. 3mm.



Ekspozytor akrylowy; podium. 3mm.

50.303 100x100x300mm Pack 5 Uni.

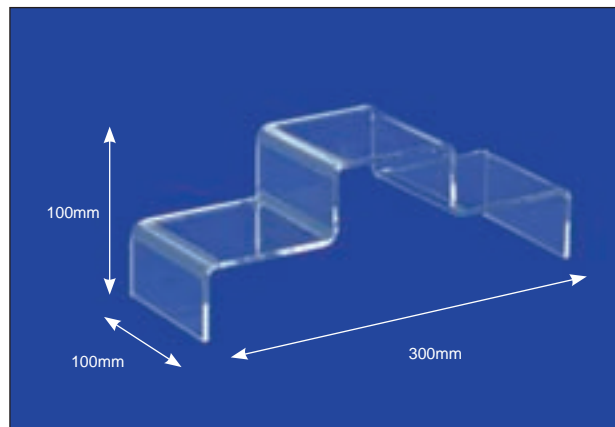

### ACRYLIC DISPLAY



Set de 3 o 4 displays acrílicos con forma de U invertida. 3mm.



Ponts acryliques de 3 ou 4 pièces. 3mm.



Set of 3 or 4 U-shaped acrylic stands. 3mm.



Conjunto de pedestais com 3 ou 4 níveis. 3mm.



Supporti in acrilico, con forma di ponte. Confezione di 3 o di 4 unità. 3mm.



Präsentations-Set aus Acryl mit 3 oder 4 U-Modulen. 3mm.



Ekspozytor akrylowy; 3-częściowy oraz 4-częściowy. 3mm.

50.309 180x180x180mm set of 3

50.308 250x150x75mm set of 4

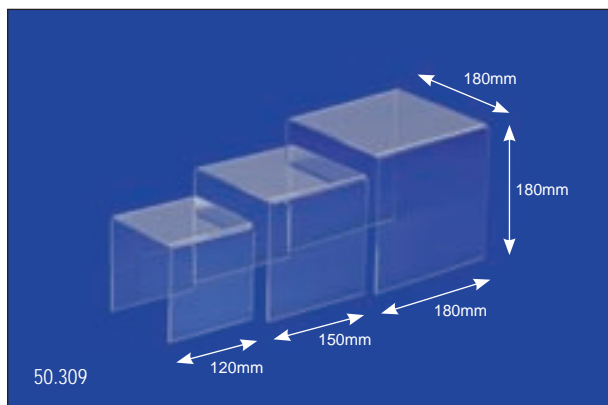

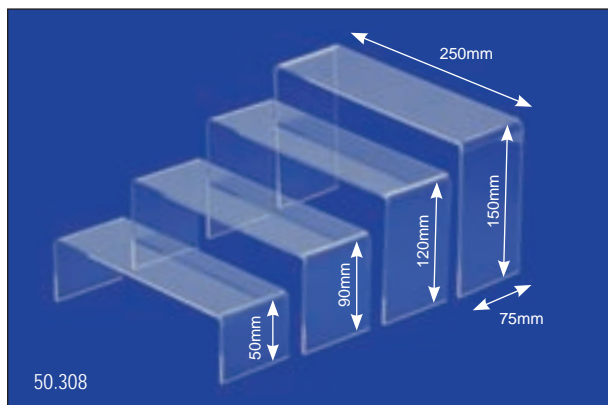

50.309



50.308

URNA DE METACRILATO / URNE D'ACRYLIQUE / COIN BOX / URNA DE ACRÍLICO / URNA IN METACRILATO / AKTIONSBOX / URNA Z PLEXI

 Urna de metacrilato con portagráficas. Disponible con y sin cerradura. Tamaño de gráfica: 150x100mm.

 Urne d'acrylique avec porte visuels. Disponible avec ou sans serrure. Formats des visuels: 150x100mm.

 Coin box sign holder. Available with locker or without lock. Graphic size: 150x100mm.

 Urna de acrílico com porta-impressões. Disponível com ou sem fecho. Tamanho da impressão: 150x100mm.

 Urna porta suggerimenti in metacrilato trasparente, disponibile con o senza la serratura. Dimensione di stampa: 150x100mm.

 Aktionsbox aus Kunststoff mit Topschild für Grafik. Verfügbar mit oder ohne Sicherheitsverschluss. Grafikgröße: 150x100mm.

 Urna akrylowa z nadstawką na grafikę. Dostępna w dwóch wersjach: zamykana na klucz lub bez zamknięcia.



QTY.	KG NW	KG GW	CBM	x y z
Uni.	1	0.36	0.56	175X220X130
				13.099

QTY.	KG NW	KG GW	CBM	x y z
Uni.	1	0.32	0.52	175X220X130
				13.100



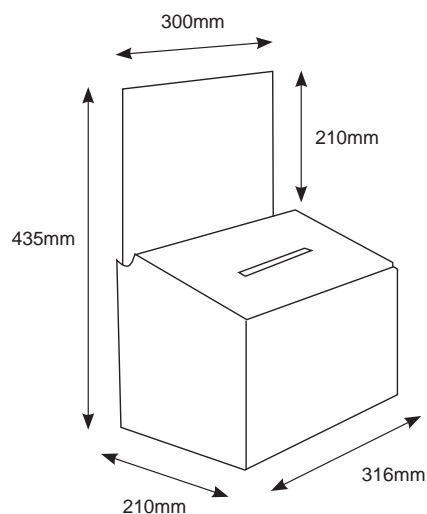

QTY.	KG NW	KG GW	CBM	x y z
Uni.	1	1.7	1.9	330X290X240
				13.124





**FILMINA / PORTE AFICHAGE / ADHESIVE OR MAGNETIC SHOWCARD / FILMINA /  
ESPOSITORI CON BANDA MAGNETICA E ADHESIVA / GRAFIKTASCHE / KIESZONKA FOLIOWA**

 Filmina con imán o adhesivo superior e inferior en la parte posterior para mayor sujeción. Tamaños: A3, A4, A5 y A6.

 Porte affiches comprenant soit un aimant ou un adhésif à l'arrière sur la partie haute et basse permettant une meilleure fixation. A3, A4, A5 y A6.

 Adhesive or magnetic showcard c-pocket PVC. Colour: transparent. Sizes: A3, A4, A5 and A6.

 Filmina com íman ou adesivo superior ou inferior na parte posterior para uma maior fixação. A3, A4, A5 y A6.

 Espositori per pareti metalliche con banda magnetica e adesiva. Tamaño: A3, A4, A5 e A6.

 Grafiktasche mit Magnet- oder Klebeband an Ober- und Unterseite. Format in DIN A3, A4, A5 und A6.

 Kieszonka foliowa mocowana do podłoża za pomocą taśmy magnetycznej lub taśmy samoprzylepnej. Wymiary: A3, A4, A5 y A6.

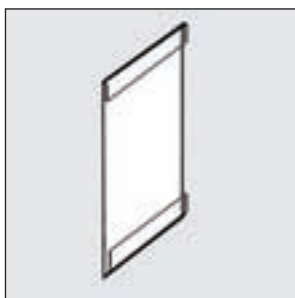

Imán / Aimant / Magnetic /  
Íman / Magnetica / Magnet / Magnes:

13.052	A3	Pack 10 Uni.
13.053	A4	Pack 10 Uni.
13.054	A5	Pack 10 Uni.
13.055	A6	Pack 10 Uni.

Adhesivo / Adhésif / Adhesive / Adesivo /  
Adesiva / Aufkleber / Taśma samoprzylepna:

13.064	A3	Pack 10 Uni.
13.065	A4	Pack 10 Uni.
13.066	A5	Pack 10 Uni.
13.067	A6	Pack 10 Uni.

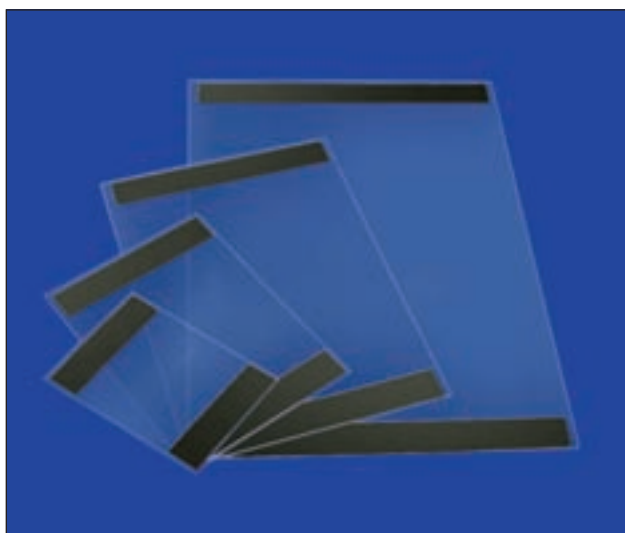

**PORTAGRÁFICAS PVC EN “T” / PORTE VISUEL EN PVC EN “T” / LEAFLET DISPENSER “T” / PORTA-IMPRESSÕES PVC EM “T” / PORTA INFORMAZIONI IN PVC “T” / T - AUFSTELLER IN PVC / STOJACZKI EKSPozyCYJNE PVC “T”**

 Portagráficas PVC a doble cara con imán a ambos lados de la base para mayor estabilidad. Tamaños: A4, A5 y A6.

 Porte visuels en PVC de double face, la base dispose de 2 aimants pour une meilleure stabilité. Disponible en A4, A5 et A6.

 Leaflet dispenser. With magnetic strip. Sizes: A4, A5 and A6.

 Porta-impressões PVC de dupla face com íman em ambos os lados da base para uma maior estabilidade. Tamanhos: A4, A5 y A6.

 Porta-informazioni in PVC, con magneti su entrambi i lati della base per maggiore stabilità. Dimensioni A4, A5 e A6.

 Doppelseitiger Werbeaufsteller aus PVC, für höhere Standsicherheit Fuß magnetisch. Format in DIN A4, A5 und A6.

 Dwustronny stojaczek ekspozycyjny “T”. Wykonany z PVC. Podstawka z magnesem dla zwiększenia stabilności stojaczka. Wymiary: A4, A5 i A6.

13.046	A4	Pack 10 Uni.
--------	----	--------------

13.047	A5	Pack 10 Uni.
--------	----	--------------

13.048	A6	Pack 10 Uni.
--------	----	--------------

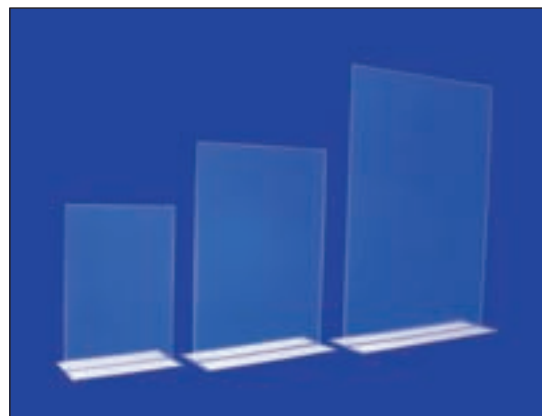
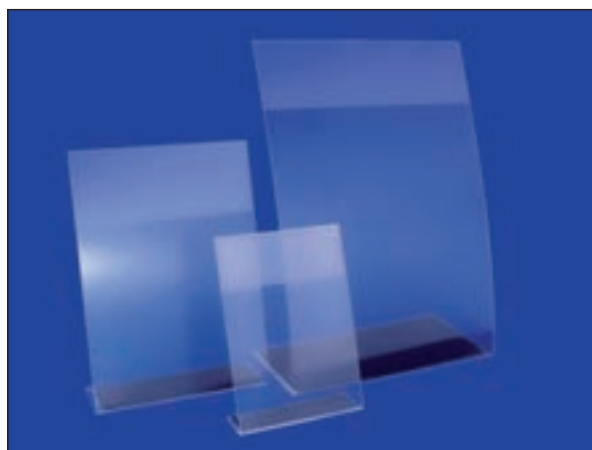

**PORTAGRÁFICAS PVC EN “L” / PORTE VISUEL DE PVC EN “L” / LEAFLET DISPENSER “L” / PORTA-IMPRESSÕES PVC EM “L” / PORTA INFORMAZIONI IN PVC “L” / L - AUFSTELLER IN PVC / STOJACZKI EKSPozyCYJNE PVC “L”**



 Portagráficas PVC con imán doble para su uso en dos posiciones. Tamaños: A4, A5 y A6.

 Porte visuel en PVC comprenant un double aimant pour une double utilisation. A4, A5 and A6.

 Leaflet dispenser. With magnetic strip. Sizes: A4, A5 and A6.

 Porta-impressões em PVC com íman duplo para poder ser usado em duas posições. Tamanhos: A4, A5 e A6.

 Porta-informazioni in PVC, con doppia calamita per l'utilizzo in due posizioni. Disponibile nei formati A4, A5 e A6.

 Werbeaufsteller aus PVC. Zum Stellen oder Hängen, da Fuß beidseitig magnetisch. Format in DIN A4, A5 und A6.

 Stojaczek ekspozycyjny wykonany z PVC. Podstawka z dwoma magnesami. Do ustawienia na stole lub zawieszania. Wymiary: A4, A5 y A6.

13.049	A4	Pack 10 Uni.
--------	----	--------------

13.050	A5	Pack 10 Uni.
--------	----	--------------

13.051	A6	Pack 10 Uni.
--------	----	--------------

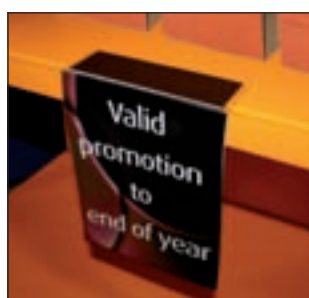

**PORTAFOLLETOS PVC / PORTE BROCHURES DE PVC / LEAFLET DISPENSER /  
PORTA-FOLHETOS PVC / PORTA DEPLIANT / PROSPEKTHALTER / POJEMNIK PVC NA PROSPEKTY**

 Portafolletos realizados en PVC transparente de 0,6mm con adhesivo y agujeros. Se suministran en plano, troquelados. Fácil montaje. Embalaje: 10 unidades.

 Porte brochures fabriqué en PVC transparent de 0.6mm, comprenant sur la partie haute un adhésif et deux trous. Montage facile. Emballages de 10 unités.

 Leaflet dispenser for shelves with adhesive strip. Material: Transparent PVC, 0,6mm. Easy and fast to assemble. Packing: 10 units.

 Porta-folhetos realizados em PVC transparente de 0,6mm. Com adesivos e furos. Distribui-se em folha plana para posterior montagem. Montagem fácil. Embalagem: 10 unidades.

 Porta cartoline di 0,6mm con adesivo e buche sul retro per posizionamento su display o ripiani. Montaggio semplice. Imballaggio 10 unità.

 Transparenter Prospekthalter aus 0,6mm PVC zum Schrauben oder Kleben. Packungsinhalt 10 Stück.

 Przezroczysty pojemnik na prospekty wykonany z PVC o grubości 0,6mm. Mocowany za pomocą taśmy samoprzylepnej. Łatwy do złożenia. Dostępny w zestawie po 10 szt.

**13.060**

 Recomendado para folletos de un tamaño aproximado al A6 vertical, de hasta 110mm de ancho por unos 180mm de alto.

 Recommandé pour des brochures d'une dimension se rapprochant de l'A6 verticale avec 110mm de longueur par 180mm de hauteur.

 Leaflet dispenser. For adhering to shelves, adhesive strip on one side. Colour: transparent. Format: A6 portrait.

 Recomendado para folhetos de um tamanho aproximado ao A6 vertical de até 110mm de comprimento por 180mm de altura.

 Raccomandato per opuscoli di una dimensione approssimativa come A6 verticale, fino a 110mm larghezza e circa 180mm altezza.

 Empfohlen für Grafiken in ca. DIN A6 vertikal. Breite bis 110mm und Höhe 180mm.

 Zalecany na prospekty w formacie pionowym A6 lub na prospekty o maksymalnych wymiarach: od 110mm (szerokość) do 180mm (wysokość).





13.060 150x220mm Pack 10 Uni.

**13.061**

 Recomendado para folletos de un tamaño aproximado al A6 horizontal, de hasta 150mm de ancho por unos 160mm de alto.

 Recommandé pour des brochures d'une dimension se rapprochant de l'A6 horizontal avec 150mm de longueur par 160mm de hauteur.

 Leaflet dispenser. For adhering to shelves, adhesive strip on one side. Colour: transparent. Format: A6 landscape.

 Recomendado para folhetos de um tamanho ao A6 horizontal de 150mm de comprimento por 160mm de altura.

 Raccomandato per opuscoli di una dimensione approssimativa come A6 orizzontale, fino a 150mm larghezza e circa 160mm altezza.

 Empfohlen für Grafiken in ca. DIN A6 horizontal. Breite bis 150mm und Höhe 160mm.

 Zalecany na prospekty w formacie poziomym A6 lub na prospekty o maksymalnych wymiarach: od 150mm (szerokość) do 160mm (wysokość).



13.061 195x207mm Pack 10 Uni.

## 13.062

 Recomendado para folletos de un tamaño aproximado al A5 vertical, de hasta 150mm de ancho por unos 260mm de alto.

 Recommandé pour des brochures d'une dimension se rapprochant de l'A5 verticale avec 150mm de longueur par 260mm de hauteur.

 Leaflet dispenser. For adhering to shelves, adhesive strip on one side. Colour: transparent. Format: A5 portrait.

 Recomendado para folhetos de um tamanho aproximado ao A5 vertical de até 150mm de comprimento por 260mm de altura.

 Raccomandato per opuscoli di una dimensione approssimativa come A5 verticale, fino a 150mm larghezza e circa 260mm altezza.

 Empfohlen für Grafiken ca. DIN A5 vertikal. Breite bis 150mm und Höhe 260mm.

 Zalecany na prospekty w formacie pionowym A5 lub na prospekty o maksymalnych wymiarach: od 150mm (szerokość) do 260mm (wysokość).

13.062 212x310mm Pack 10 Uni.

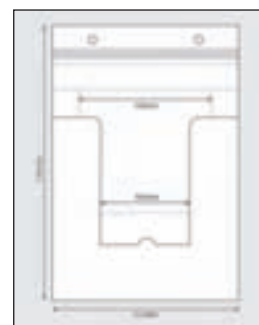
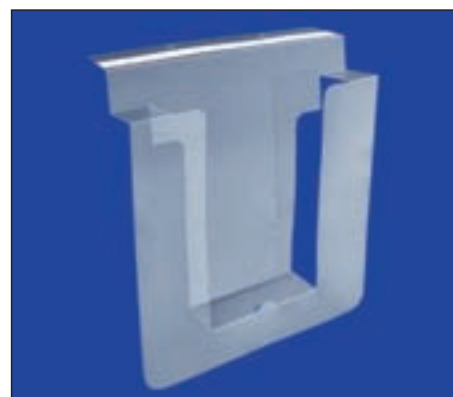



## 13.063

 Recomendado para folletos de un tamaño aproximado al A6 vertical, de hasta 105mm de ancho por unos 160mm de alto.

 Recommandé pour des brochures d'une dimension se rapprochant de l'A6 verticale avec 105mm de longueur par 160mm de hauteur.

 Leaflet dispenser. Easy to assemble. A6 portrait.

 Tamanho aproximado ao A6 vertical de até 105mm de comprimento por 160mm de altura.

 Portadepliant da banco pieghevole. Adatto ad ogni ambiente, è la soluzione più comoda e versatile. Raccomandato per opuscoli A6 verticale

 Empfohlen für Grafiken ca. DIN A6 vertikal. Breite bis 105mm und Höhe 160mm.

 Zalecany na prospekty w formacie pionowym A6 lub na prospekty o maksymalnych wymiarach: od 105mm (szerokość) do 160mm (wysokość).

13.063 106x140mm Pack 10 Uni.

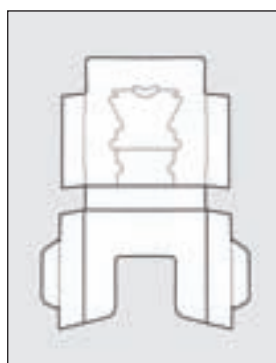
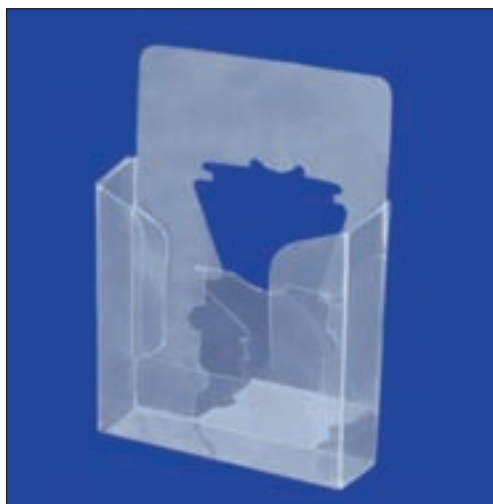



PORTAFOLLETOS METÁLICO / PORTE BROCHURES MÉTALLIQUE / LEAFLET HOLDER / PORTA-FOLHETOS METÁLICO / ESPOSITORI / METALL PROSPEKTHALTER / STOJACZKI METALOWE

 Portafolletos de sobremesa. Fabricados en acero pintado en color blanco.

 Portes brochures à poser sur une table. Fabriqué en acier, couleur blanc.

 Leaflet Holder. Material: powder coated wire. Colour: white.

 Porta-folhetos para colocar sob mesa para folhetos. Fabricados em aço pintado de branco.

 Espositori da banco. Fabbricato in acciaio verniciato bianco.

 Tisch - Prospekthalter aus Stahl in der Farbe Weiß.

 Stojaczki metalowe na prospekty. Wykonane z drutu stalowego. Malowane proszkowo na kolor biały.



QTY.	 Kg NW	 Kg GW	CBM	x 
				y z

Uni.	1	0.45	0.65	0.015	250X385X160
------	---	------	------	-------	-------------

13.056 2 x A4



QTY.	 Kg NW	 Kg GW	CBM	x 
				y z

Uni.	1	0.55	0.75	0.022	245X435X210
------	---	------	------	-------	-------------

13.057 3 x A4



QTY.	 Kg NW	 Kg GW	CBM	x 
				y z

Uni.	1	0.40	0.60	0.007	140X345X160
------	---	------	------	-------	-------------

13.058 3 x A6



QTY.	 Kg NW	 Kg GW	CBM	x 
				y z

Uni.	1	1.15	1.35	0.036	475X430X180
------	---	------	------	-------	-------------

13.059 4 x A4

PORTAFOLLETOS METÁLICO / PORTE BROCHURES MÉTALLIQUE / LEAFLET HOLDER /  
 PORTA-FOLHETOS METÁLICO / ESPOSITORI METALLICO / METALL PROSPEKTHALTER / STOJACZKI METALOWE

 Portafolletos metálicos de sobremesa o a pared cromados.

 Porte brochures métallique chromé à poser ou à fixer au mur.

 Leaflet Holder. Chromed metal literature holders. Rubber feet protect countertop surfaces.

 Porta-folhetos em metálico cromado para colocar sobre mesas ou na parede.

 Espositori metallico cromato da banco o parete.

 Prospekthalter aus verchromtem Stahl für Tisch oder Wand.

 Stojaczki metalowe na prospekty. Posiadają stopkiantypoślizgowe. Do ustawienia na biurku, ladzie lub do zawieszenia na ścianie.



QTY.	KG NW	KG GW	CBM	x	y	z
Uni.	1	0.35	0.55	0.010	270X270X150	
			13.117		1 x A4	



QTY.	KG NW	KG GW	CBM	x	y	z
Uni.	1	0.65	0.85	0.027	270X450X230	
			13.118		3 x A4	



QTY.	KG NW	KG GW	CBM	x	y	z
Uni.	1	0.70	0.90	0.029	270X470X230	
			13.119		3 x A4	



QTY.	KG NW	KG GW	CBM	x	y	z
Uni.	1	0.60	0.80	0.015	270X295X200	
			13.120		4 x 1/3 A4	

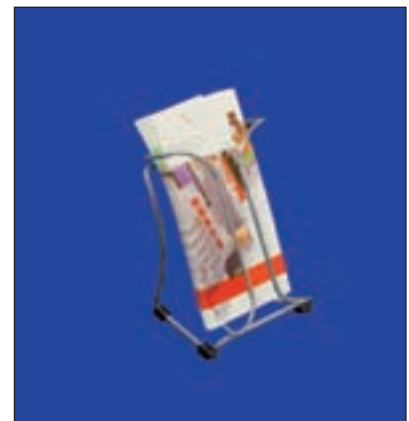

QTY.	KG NW	KG GW	CBM	x	y	z
Uni.	1	0.25	0.45	0.004	135X220X140	
			13.121		1/3 A4	